

# FMS Series MORSE e CUBI-MORSA - VISES and VISE -TOWERS

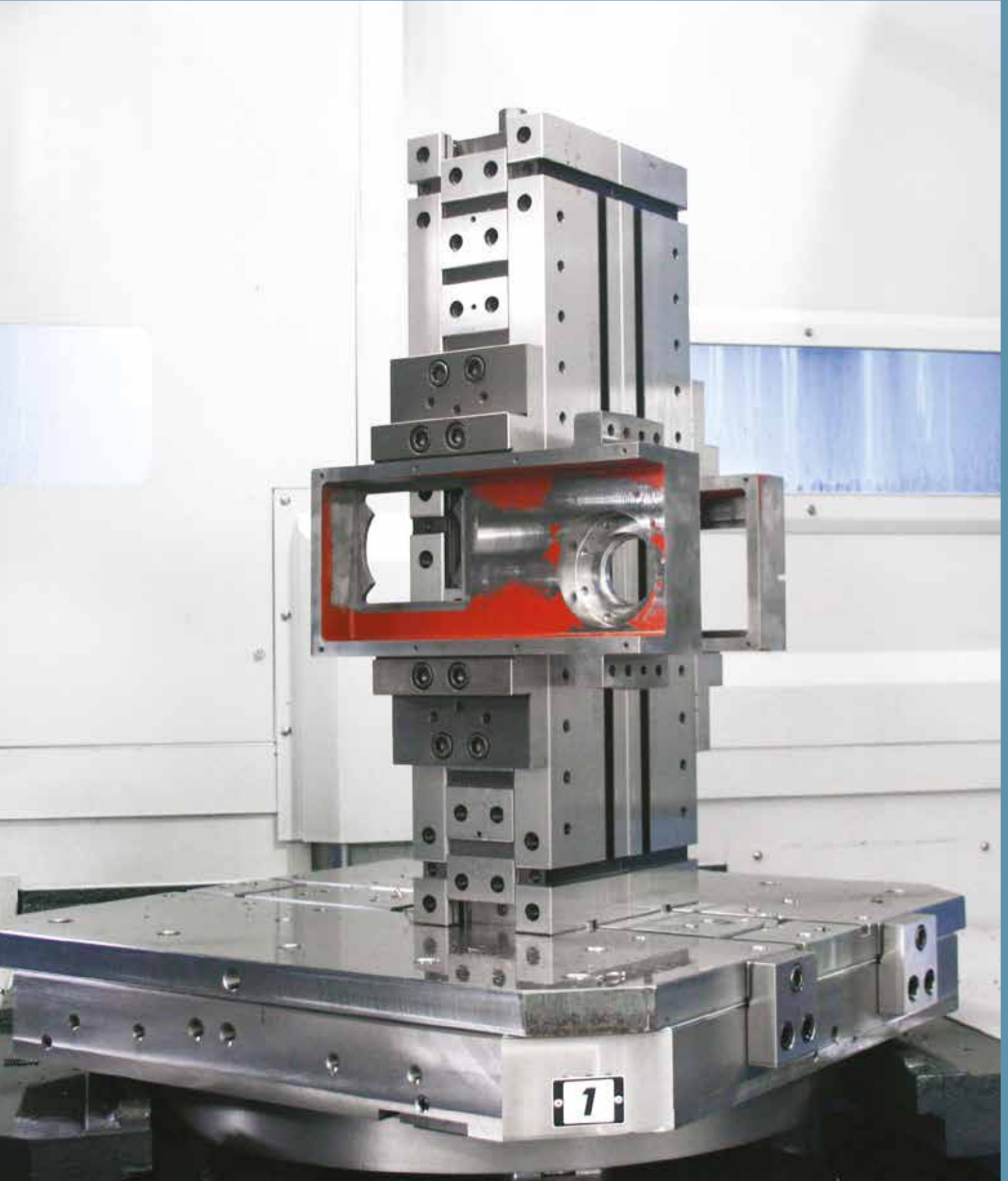

**INDICE - INDEX**

Art.	Pag 5.	Art.	Pag 5.	Art.	Pag 5.	Art.	Pag 5.	Art.	Pag 5.
<b>62</b>	46 - 67 - 69	<b>805T</b>	55	<b>813A</b>	29	<b>863F</b>	14		
<b>84U</b>	29	<b>805U</b>	29	<b>813C</b>	29	<b>864</b>	16		
<b>90</b>	33	<b>805UA</b>	29	<b>814</b>	56	<b>865</b>	18		
<b>99A</b>	67 - 69	<b>805V</b>	33	<b>815</b>	29	<b>865D</b>	18		
<b>99B</b>	67 - 69	<b>806</b>	20	<b>815A</b>	29	<b>865E</b>	18		
<b>99H</b>	67 - 69	<b>806A</b>	20	<b>815C</b>	29	<b>865F</b>	18		
<b>99S</b>	67 - 69	<b>806B</b>	21	<b>818</b>	50	<b>866</b>	22		
<b>220 G01</b>	58	<b>806C</b>	21	<b>821</b>	52	<b>866D</b>	22		
<b>220 G02</b>	58	<b>806D</b>	21	<b>822</b>	52	<b>866E</b>	22		
<b>220 G11</b>	58	<b>806E</b>	21	<b>823</b>	59	<b>866F</b>	22		
<b>266A</b>	63	<b>806F</b>	20-21	<b>823B</b>	59	<b>867</b>	26		
<b>266B</b>	63	<b>806G</b>	21	<b>825</b>	59	<b>867D</b>	26		
<b>247T</b>	33	<b>806H</b>	21	<b>825A</b>	61	<b>867E</b>	26		
<b>512</b>	57	<b>806M</b>	21	<b>825B</b>	59	<b>867F</b>	26		
<b>547G</b>	58	<b>807</b>	20	<b>825C</b>	59	<b>868</b>	30		
<b>566</b>	62	<b>807A</b>	20	<b>827</b>	60	<b>868D</b>	30		
<b>571</b>	62	<b>808</b>	20	<b>827A</b>	60	<b>868E</b>	30		
<b>800</b>	36	<b>808A</b>	20	<b>828</b>	60	<b>868F</b>	30		
<b>800A</b>	36	<b>808B</b>	20	<b>828A</b>	60	<b>870</b>	34		
<b>800B</b>	36	<b>810</b>	56	<b>829A</b>	50	<b>870A</b>	54		
<b>800C</b>	40-41	<b>810A</b>	56	<b>830</b>	50	<b>870C</b>	44		
<b>800D</b>	36	<b>810B</b>	56	<b>831</b>	59	<b>870D</b>	34		
<b>800E</b>	61	<b>810D</b>	56	<b>832</b>	59	<b>870E</b>	34		
<b>800I</b>	61	<b>810DT</b>	57	<b>833</b>	59	<b>870F</b>	34 - 65		
<b>801</b>	46	<b>810E</b>	57	<b>834</b>	59	<b>870G</b>	65		
<b>801G</b>	61	<b>810J</b>	56 - 57	<b>835</b>	60	<b>870J</b>	66		
<b>801H</b>	61	<b>810K</b>	57	<b>836</b>	60	<b>870L</b>	66		
<b>801I</b>	61	<b>810L</b>	57	<b>837</b>	60	<b>890</b>	62 - 65		
<b>801S</b>	61	<b>810M</b>	57	<b>838</b>	60	<b>890K/1</b>	62		
<b>802</b>	71	<b>810O</b>	16 - 56 - 57	<b>850B</b>	61	<b>890K/2</b>	63		
<b>804</b>	48	<b>810P</b>	57	<b>850C</b>	61	<b>890K/3</b>	63		
<b>805</b>	54	<b>810Q</b>	29	<b>850E</b>	61	<b>890K/4</b>	64		
<b>805A</b>	54	<b>810QA</b>	29	<b>850H</b>	61	<b>891</b>	62		
<b>805B</b>	54	<b>810R</b>	57	<b>850P</b>	61 - 78	<b>892</b>	62		
<b>805C</b>	54	<b>810T</b>	57	<b>850T</b>	61	<b>895</b>	64		
<b>805D</b>	55	<b>810U</b>	29	<b>852</b>	60	<b>900</b>	38		
<b>805DT</b>	55	<b>810UA</b>	29	<b>853</b>	60	<b>900Y</b>	38		
<b>805E</b>	55	<b>810UZ</b>	29	<b>855</b>	10	<b>983</b>	3		
<b>805F</b>	16 - 54 - 55	<b>810V</b>	57	<b>855C</b>	42	<b>DPG250</b>	66		
<b>805G</b>	16 - 55	<b>810W</b>	25	<b>855D</b>	10	<b>DIVIGER 205</b>	68		
<b>805H</b>	55	<b>810WA</b>	25	<b>855E</b>	10				
<b>805I</b>	55	<b>810X</b>	16 - 25	<b>855F</b>	10				
<b>805J</b>	55	<b>810XA</b>	25	<b>860</b>	12				
<b>805K</b>	55	<b>810Y</b>	25	<b>860C</b>	42				
<b>805L</b>	55	<b>810YA</b>	25	<b>860D</b>	12				
<b>805M</b>	55	<b>810Z</b>	25	<b>860E</b>	12 - 81				
<b>805N</b>	54 - 55	<b>812</b>	29	<b>860F</b>	12				
<b>805O</b>	54 - 55	<b>812A</b>	29	<b>863</b>	14				
<b>805P</b>	55	<b>812B</b>	29	<b>863C</b>	44				
<b>805Q</b>	55	<b>812C</b>	29	<b>863D</b>	14				
<b>805R</b>	55	<b>813</b>	29	<b>863E</b>	14				

# VALIGETTA DI CAMPIONATURA FMS (Art.860)

## SAMPLE KIT CASE FMS (Art.860)

**NEW!**

**Art. 983**

 Valigetta di campionatura morsa Art.860 T.1x300  
 Sample kit case Art.860 T.1x300 vise

Cod. 0.98.30000

**All'Interno - Inside:**

Art.810L	Art. 806B	Art.297 16/18
Art. 807	Art. 806C	Art.850H
Art. 810X	Art.806D	Art.370 T1 Std
Art. 814	Art.806E	Art.375 CH12
Art. 810J	Art.806F	- -
Art. 814	Art.298	- -



## SIMBOLOGIA DATI TECNICI

## TECHNICAL DATA ICONS

**5**

GANASCE JAWS		Piane Straights		A gradino With step		Oscillanti a gradino Floating step		Oscillanti regolabili Floating adjustable		Alte e rialzate High and raised		Prismatiche Prismatic
	PIASTRE GANASCE JAW PLATES			Discendente Pull down		Piana Straight		Cambio rapido manuale Quick manual change		GRIP GRIP		Inserti GRIP Inserti GRIP
POSSIBILITÀ DI POSSIBILITY OF									Predisposizione Zero Point Zero Point Ready		Cubi-morsa Vise tower	
	PAGINE PAGES			Lavorazioni a 5 assi 5 axis machining		Accessori & Ricambi Accessories & Spare Parts		Istruzioni corretto utilizzo Instruction for a proper use		Diagrammi forze di serraggio Clamping force diagrams		Sistema Idraulico Hydraulic System

# SISTEMA MODULARE FLESSIBILE

## FLEXIBLE MODULAR SYSTEM



**Morse e Cubi-Morsa serie FMS - Morse Singole, Doppie, Autocentranti & centinaia di ganasce disponibili**  
**FMS vises and Vise-Towers series - Single, Double and Self-centering Vises and hundreds of jaws available**

Di speciale interesse per gli utilizzatori di centri di lavoro orizzontali e verticali le morse FMS presentano le stesse caratteristiche costruttive illustrate per le morse della serie STD, XL, gli elementi modulari e gli accessori (accuratamente rettificate in acciaio ad alta resistenza cementato e temprato con durezza 60 HRC).

Nata espressamente per i centri di lavoro, la gamma FMS permette ottimizzazioni di serraggio con riferimenti precisi in spazi contenuti, usure inesistenti e rigidità impensabile (spessore della base raddoppiato), possibilità di bloccare più pezzi contemporaneamente con l'ausilio di sistemi meccanici, pneumatici, elettrici o idraulici. Tutte sono disponibili/predisposte sia per piazzamenti verticali che orizzontali. Ganasce da 75 a 190 mm. Serraggi di qualsiasi lunghezza.

La caratteristica (Brevetata) che meglio contraddistingue questa serie di morse consiste nella possibilità di trasformare ogni morsa singola (cioè adibita al serraggio di un singolo pezzo) in una morsa autocentrante con bloccaggio concentrico dall'esterno all'interno e viceversa e in morsa doppia tramite la semplice sostituzione delle ganasce sul corpo base universale. Un semplice e rapido accorgimento permetterà quindi le seguenti alternative di serraggio: un singolo pezzo lungo, due pezzi più piccoli oppure operare in modo autocentrante. Tutto ciò ne suggerisce l'impiego in situazioni produttive caratterizzate da lotti di pezzi estremamente diversi fra loro riducendo tempi di set-up e garantendo un'accurata ripetibilità di posizionamento e quindi di precisione migliorando l'efficienza globale del sistema produttivo.

Of special interest to horizontal and vertical machining centres users FMS vises present the same building characteristics of STD and XL vises, modular elements and accessories (hardened HRC 60 & ground steel construction throughout). Born to be dedicated to machining centres, FMS series of vises allow workholdings with perfect alignment in a space saving design, extremely high wear resistance, with deflection reduced 2 times in respect to the STD modular vises (base thickness doubled), possibility to clamp more pieces simultaneously with mechanic, hydraulic pneumatic or electric devices. You can use them both for vertical and horizontal clamping without any price charge. Jaws widths from 75 to 190 mm. Grip any work length.

The feature (Patented) which identifies this line of vises consists in the possibility to transform each single vise (1 piece clamping) in a self-centering vise with possibility to block from outside to inside and viceversa and in a double vise through the simple substitution of the jaws on the universal vise body base.

A simple and quick adjustment will then allow following clamping alternatives: single long piece, 2 smaller pieces or to operate in the self-centering way.

All that suggests their use in the production of lots of highly different pieces reducing set-up times and assuring very accurate repetability of workpiece position and precision, increasing the global efficiency of the production process.



### ESTREMA VERSATILITÀ

- 3 posizioni per la ganasce fissa; ▪ Serraggio dall'esterno all'interno e viceversa;
- Posizionamento verticale-orizzontale-laterale; ▪ Collegamento: fianco a fianco, dorso a dorso, fianco a dorso; ▪ Possibilità illimitata per ganasce speciali; ▪ Sostituzione semplice e precisa delle ganasce; ▪ Elemento di prolunga per pezzi fuori misura;
- Sistema di serraggio meccanico, idraulico, pneumatico elettrico o con moltiplicatore di potenza, tramite comando manuale, a pedale o mediante pulsante elettrico (vedi pag. 12); ▪ Costruzione solida e compatta e massima apertura rispetto alla sua lunghezza; ▪ Flessioni praticamente ridotte di due volte rispetto alle precedenti morse modulari standard; ▪ Accurata ripetibilità di posizionamento del pezzo da lavorare; ▪ Precisioni geometriche con tolleranze entro 0,02 mm; ▪ Protezione integrale dalla penetrazione di corpi estranei tramite piastre scorrevoli; ▪ Possibilità di trasformazione di ogni morsa singola in morsa autocentrante o in morsa doppia tramite la semplice sostituzione delle ganasce sul corpo base universale.

### EXTREME VERSATILITY

- 3 positions for the fixed jaw; ▪ Outside to inside clamping and viceversa; ▪ Vertically, horizontally and sideways vise positioning;
- Side to side, back to back and back to side vise positioning; ▪ Unlimited special jaws; ▪ Simple and precise exchange of jaws;
- Extension element for extra-long pieces; ▪ Mechanic, hydraulic or pneumatic or electrical clamping system or with pressure multiplier, through manual, pedal or push button board control (see page 12); ▪ Space saving design, solid construction and maximum blocking ratio to total length; ▪ Deflection reduced two times with respect to the STANDARD modular vises; ▪ Very accurate repetability of workpiece position; ▪ Geometrical accuracy with tolerances within 0,02 mm; ▪ Integral protection from chips and dirty through sliding protection; ▪ Possibility to transform each single vise in a self-centering vise with possibility to block from outside to inside and vice versa and in a double vise through the simple substitution of the jaws on the universal vise body base.

**1 SISTEMA TERZA MANO**

Per preserraggi in verticali

**1 THIRD HAND SERVICE**

For vertical workpieces preload

**3 GANASCE MOBILI OSCILLANTI**

Ganasce mobili oscillanti (per serraggio di pezzi irregolari)

**3 STEP MOVABLE JAWS**

Floating movable jaws (for irregular workpieces)

**5 GANASCE MOBILI A GRADINO**

Ganasce mobili a gradino (ideali per fori passanti)

**5 STEP MOVABLE JAWS**

Step movable jaws (for drilling holes through)

**7 GANASCIA FISSA DOPPIA**

Ganasce centrali fisse doppie con gradino piccolo e grande

**7 DOUBLE FIXED JAWS**

Central double fixed jaws with small and large step

**9 CHIAVETTE di POSIZIONAMENTO**

Chiavette longitudinali e trasversali sia sulla base, per posizione orizzontale, che in testa per posizione verticale

**9 POSITIONING KEYWAYS**

Longitudinal and cross keyways both on the base bottom surface for horizontal positioning and on the side for vertical positioning

**10 VITE PRINCIPALE**

All'interno vite principale (completamente protetta) con filetto destro e sinistro

**10 MAIN SPINDLE**

Inside (completely protected) main spindle with left and right thread

**2 3 MORSE IN UNA**

Ghiera per trasformazione morsa da doppia in autocentrante e viceversa

**2 3 VISES IN ONE**

Nut for vise configuration resetting from double to self-centering and viceversa

**4 GANASCE A CAMBIO RAPIDO**

Ganasce con piastre discendenti a cambio rapido manuale

**4 COMB SYSTEM JAWS**

Pull down jaw plates with comb system (quick hand change)

**6 RIGIDITÀ CUBO MORSA**

Cubo monoblocco

**6 VISE TOWER RIGIDITY**

Solid vise tower

**8 SLITTE MORSA**

Slitte destre e sinistre lunghe quanto il corpo base con più chiavette per ganasce mobili

**8 VISE SLIDES**

Left and right slides long as the vise base with multiple movable jaw positions

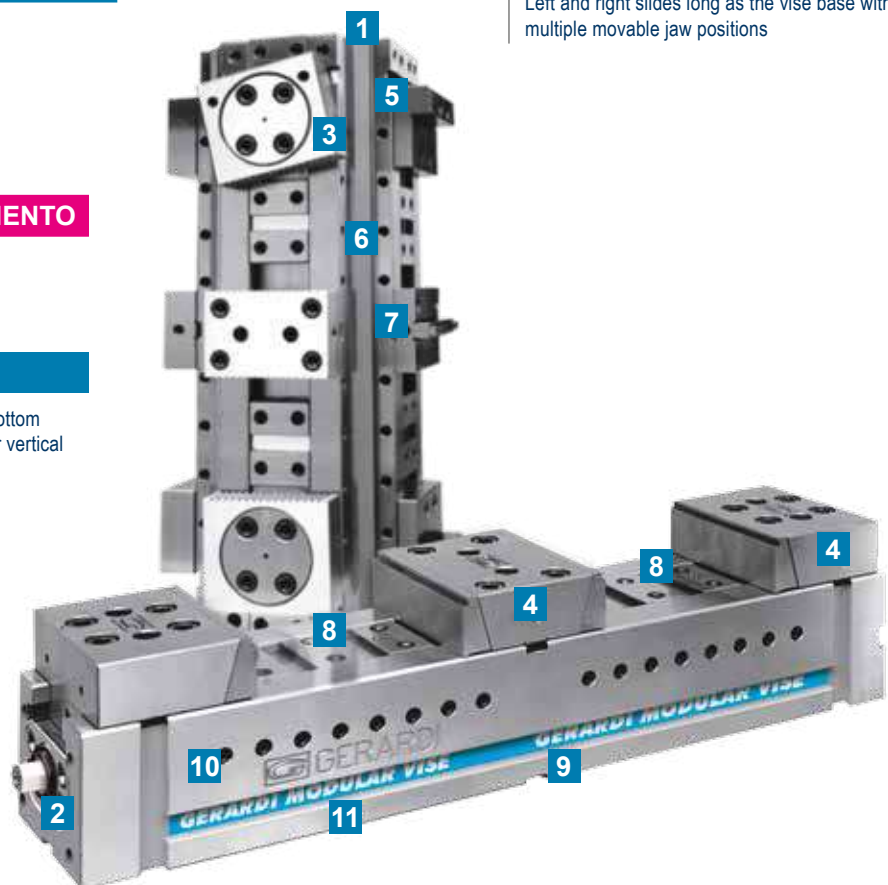
**11 RIGIDITÀ MORSA**

Base con una sezione doppia per garantire una maggiore rigidità

**11 VISE BASE RIGIDITY**

Higher vise base in order to guarantee a better rigidity



# TRE MORSE IN UNA THREE VISES IN ONE

3 MORSE IN  
VISES IN 1

Acquista il modulo base universale. Una soluzione aperta per il lavoro di oggi pensando a quello di domani !  
Buy the base body. A Versatile solution for present and future machining !

## CORPO BASE Art.855

## BASE BODY Art.855

Modulo base universale  
CENTINAIA DI GANASCE DISPONIBILI !!

Universal vise body module  
HUNDREDS OF JAWS AVAILABLE !!



Ganascia fissa  
Fixed jaw

## SERRAGGI SINGOLI

## SINGLE CLAMPING

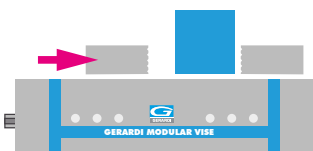

Ganascia mobile  
Movable jaw

## SERRAGGI DOPPI

## DOUBLE CLAMPING

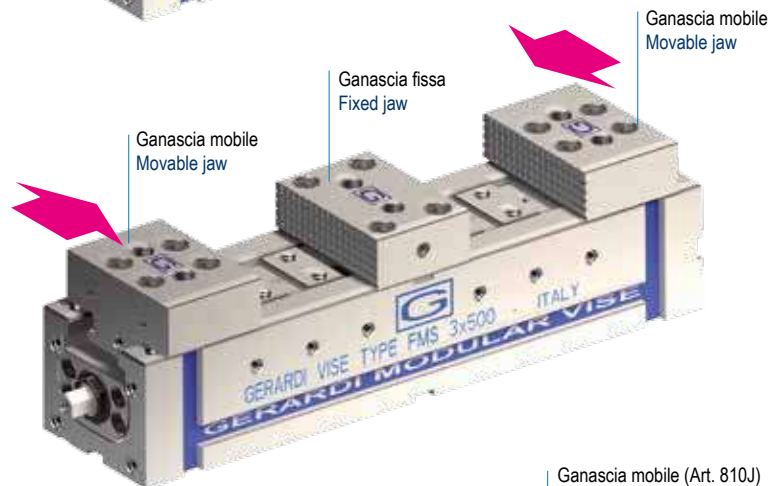

Ganascia mobile  
Movable jaw

Ganascia fissa  
Fixed jaw

Ganascia mobile  
Movable jaw

## AUTOCENTRANTE

## SELF-CENTERING

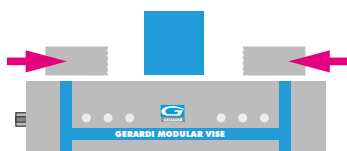

Ganascia mobile (Art. 810J)  
Movable jaw (Art. 810J)

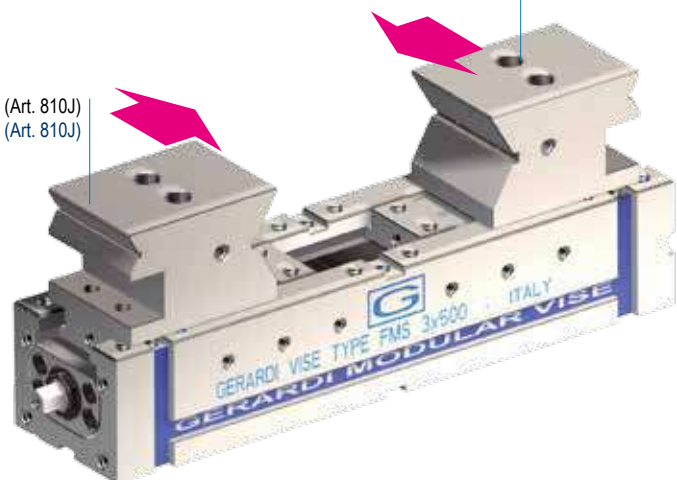

Ganascia mobile (Art. 810J)  
Movable jaw (Art. 810J)

**VERSIONI PER BLOCCAGGI DOPPI**  
**DOUBLE CLAMPING CONFIGURATION**

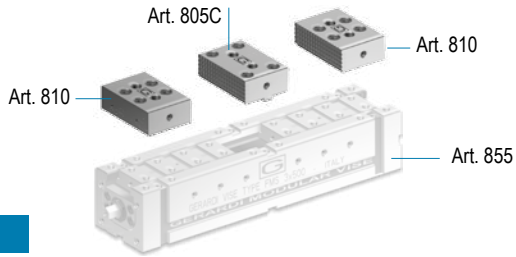

**Art. 860**

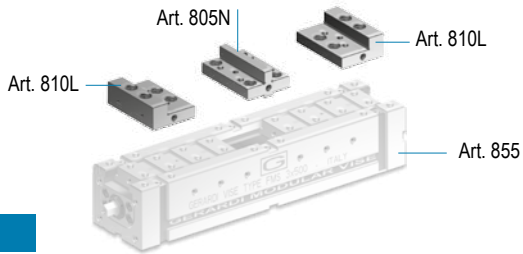

**Art. 863**

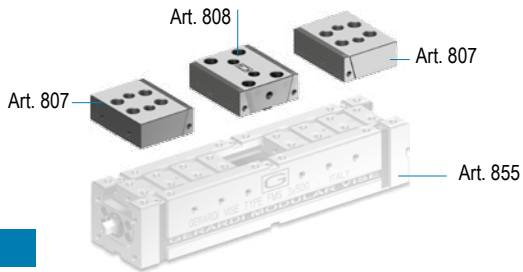

**Art. 865**

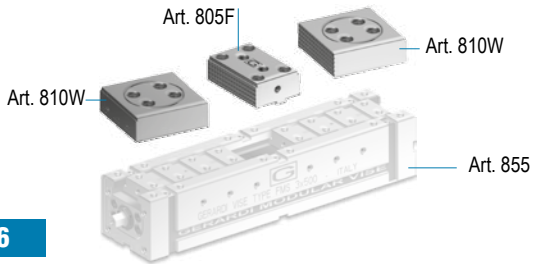

**Art. 866**

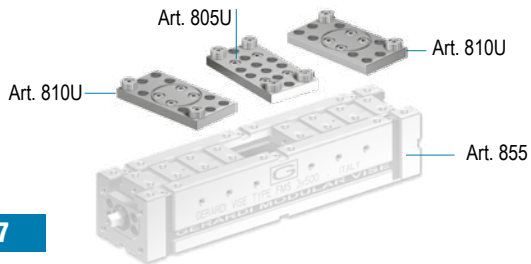

**Art. 867**

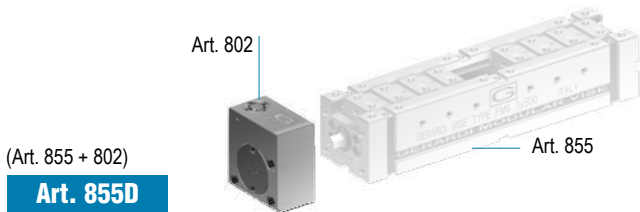

**Art. 855D**

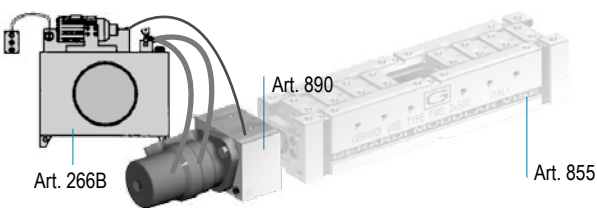

**Art. 855F**

(Art. 855 + 890 + 266B)

**VERSIONI AUTOCENTRANTI**  
**SELF-CENTERING TYPE**

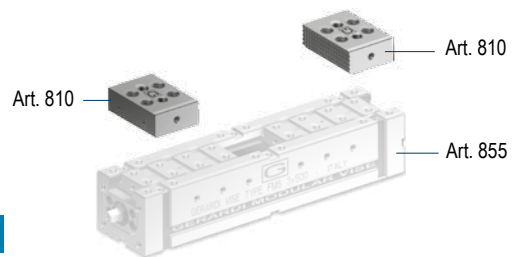

**Art. 860**

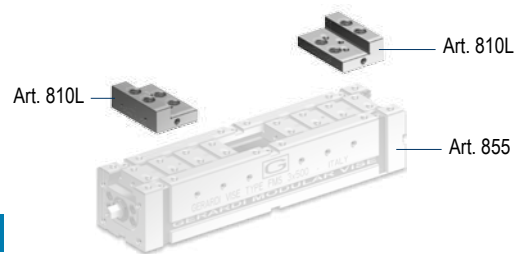

**Art. 863**

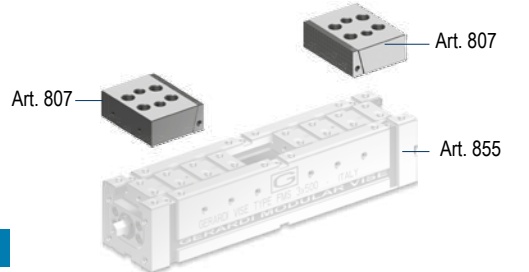

**Art. 865**

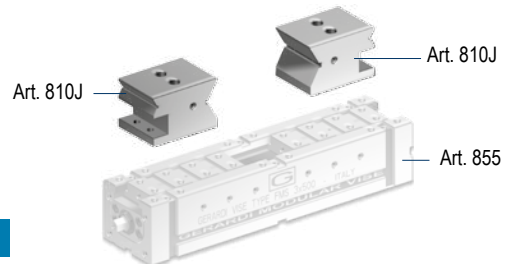

**Art. 870**

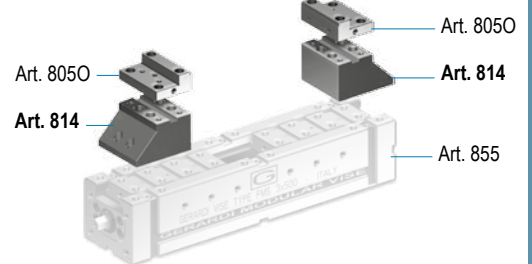

**Art. 868**

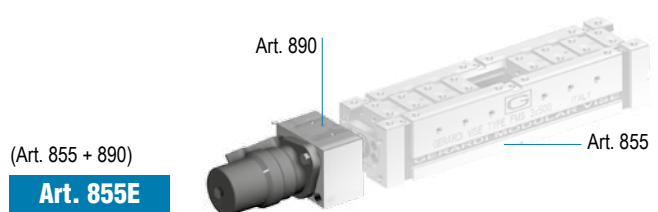

**Art. 855E**

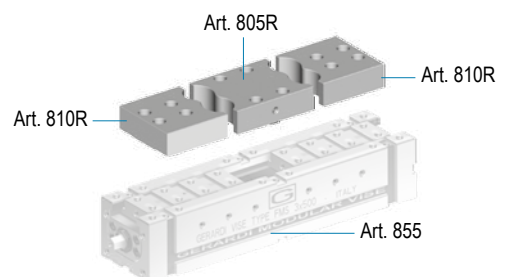

# CUBI DI MORSE MONTATI A CROCE O DORSO A DORSO VISE TOWERS CROSS OR BACK TO BACK MOUNTED

Art.850P (Pag - Page 5.61)

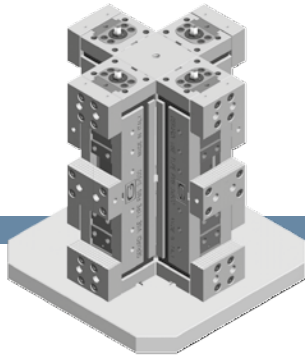

**N° 4 MORSE FMS**  
montate a croce su piastra base (Art. 827)  
con distanziali (Art. 835)

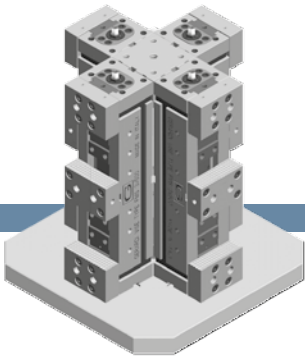

**N° 4 FMS VISES**  
cross-mounted on base plate (Art. 827)  
with spacers (Art. 835)

**N° 4 MORSE FMS**  
montate a croce su piastra base (Art. 827)  
con supporto centrale (Art.836)

**N° 4 FMS VISES**  
cross-mounted on base plate (Art.827)  
with center support (Art.836)

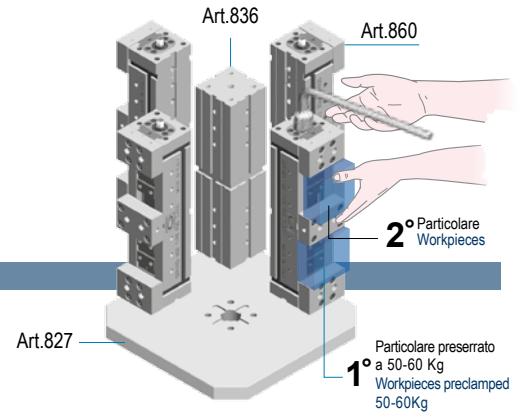
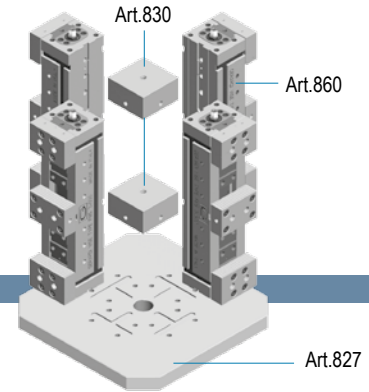

1° Particolare preserrato a 50-60 Kg  
Workpieces preclamped 50-60Kg

## MECCANISMO TERZA MANO INCLUSO THIRD HAND DEVICE INCLUDED

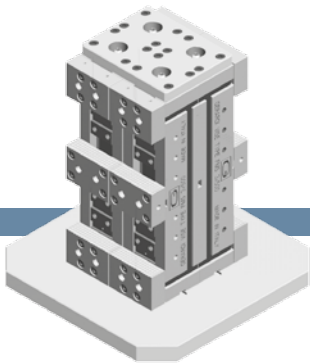

**N° 4 MORSE FMS**  
montate dorso a dorso, fianco a fianco, su piastra base  
(Art. 827) con piastra di collegamento (Art. 832)

**N° 4 FMS VISES**  
cross-mounted back-to-back,side by side, on base  
plate (Art. 827) with connecting plate (Art. 832)

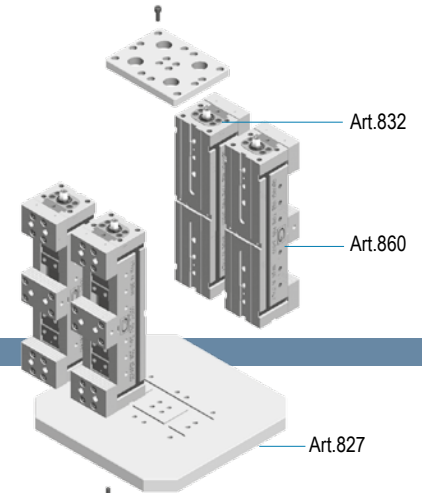

**N° 4 MORSE FMS**  
montate dorso a dorso, su piastra base  
(Art. 827) con piastra di collegamento (Art. 832)

**N° 4 FMS VISES**  
cross-mounted back-to-back,on base plate  
(Art. 827) with connecting plate (Art. 832)

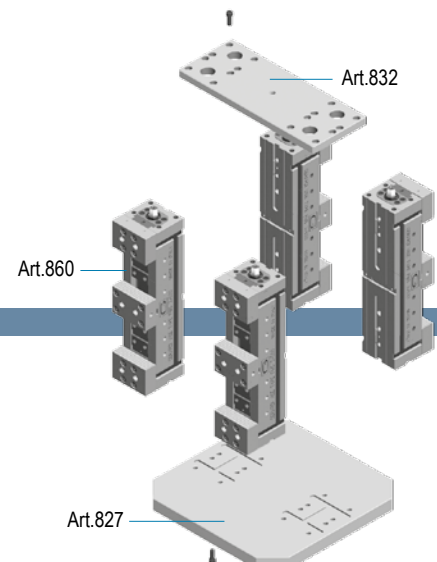

Montaggio morsa con distanziali, supporto centrale o piastra di collegamento €125  
Vise mounted with spacers, center support or connecting plate €125 each



# CUBI DI MORSE MONTATI VERTICALMENTE VISE TOWERS VERTICALLY ASSEMBLED

Art.850P (Pag - Page 5.70)

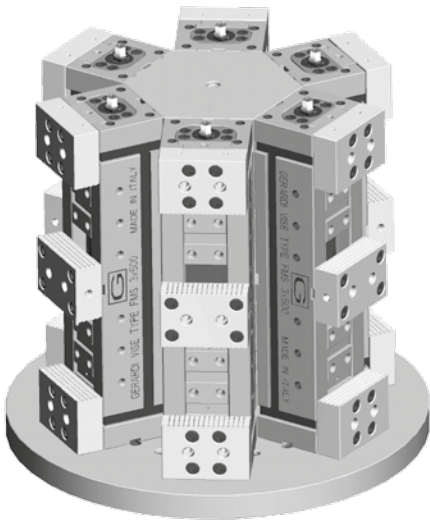

## N° 6 morse FMS

montate verticalmente su piastra base (Art. 827) con distanziali esagonali (Art. 838)

## N° 6 FMS vises

vises vertically mounted on base plate (Art. 827) with exagon spacer (Art. 838)

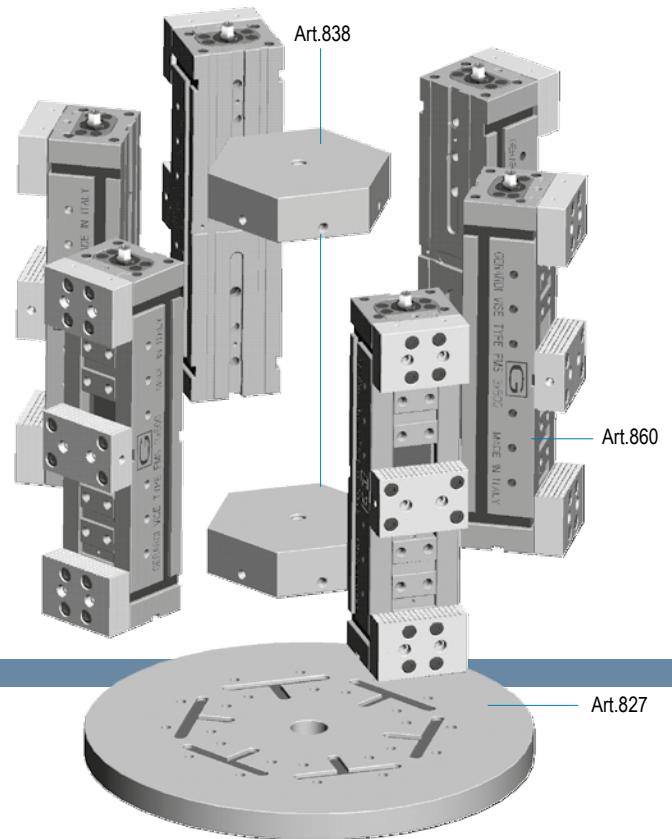

## MECCANISMO TERZA MANO INCLUSO THIRD HAND DEVICE INCLUDED

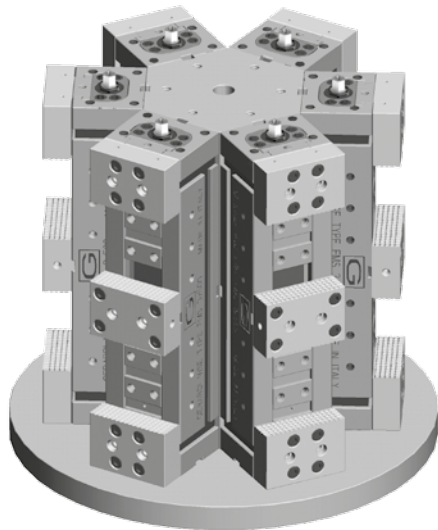

N° 6 morse FMS montate verticalmente su piastra base (Art. 827) con supporto centrale (Art. 837)

N° 6 FMS vises vertically mounted on base plate (Art. 827) with exagon center support (Art. 837)

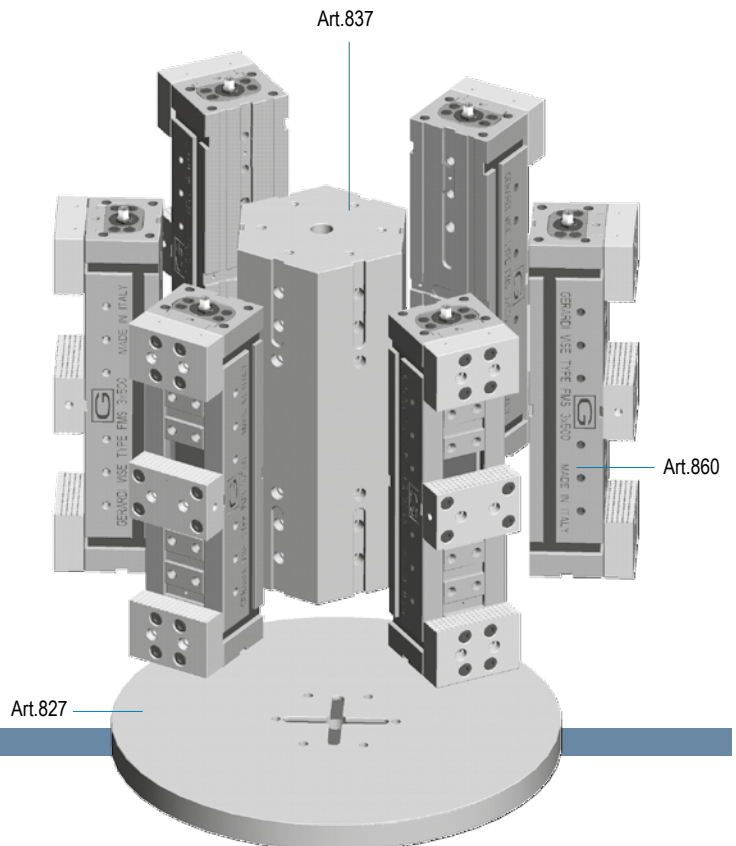

Montaggio morse con distanziali, supporto centrale o piastra di collegamento €125 cad.  
Vise mounted with spacers, center support or connecting plate €125 each

Tipo (grandezza) morsa / Vise type (size)		1 25 kN		2 25 kN			3 30 kN		
		kN							
Apertura massima fra le slitte / Maximum opening between slides	A	56	68	96	116	136	156	136	136
	C	70		90			100		
	D	200 + 32	300 + 32	300	400	500	600	400	500
	E	249	349	320	420	520	620	425	525
	G	75		95			125		
	R	74		94			124		
	S	69		89			99		
	T	72	116	102	142	182	222	132	182
	Y	277	377	360	460	560	660	470	570
	X	389	483	537	637	737	837	637	737
	kg	7	10	18	25	32	39	40	45
	Cod.	5.85.51200	5.85.51300	5.85.52300	5.85.52400	5.85.52500	5.85.52600	5.85.53400	5.85.53500

**Art. 855**



Modulo base universale

**CENTINAIA DI GANASCE DISPONIBILI !!**

 Universal vise body module  
**HUNDREDS OF JAWS AVAILABLE !!**
**Art. 855D**

(Art. 855 + 802) Morsa + moltiplicatore di coppia / Vise + torque multiplier

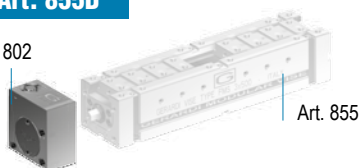
Art. 802



Cod. 5.85.5D120 5.85.5D130 5.85.5D230 5.85.5D240 5.85.5D250 5.85.5D260 5.85.5D340 5.85.5D350

**Art. 802**



Moltiplicatore di coppia con rinvio angolare - Mechanical with torque multiplier with angular transmission

Cod. 5.80.21000 5.80.22000 5.80.23000

**Art. 855E**

(Art. 855 + 890) Morsa + motore idraulico / Vise + hydraulic motor

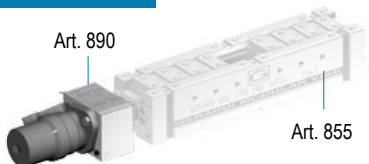
Art. 890



Cod. 5.85.5E120 5.85.5E130 5.85.5E230 5.85.5E240 5.85.5E250 5.85.5E260 5.85.5E340 5.85.5E350

Meccanica con predisposizione elettroidraulica completa di motore, piastra, boccola e finecorsa

**Art. 855F**

(Art. 855 + 890 + 266B) Morsa + motore idraulico + centralina / Vise + hydraulic motor + power unit

Art. 855

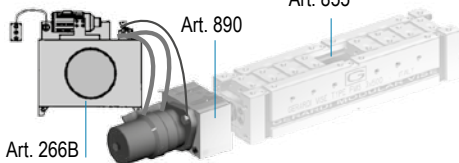

Cod. 5.85.5F120 5.85.5F130 5.85.5F230 5.85.5F240 5.85.5F250 5.85.5F260 5.85.5F340 5.85.5F350

Meccanica elettroidraulica completa di centralina idraulica apparecchiatura elettrica con pulsantiera

**Dotazione standard:**

- 2 arresti laterali Art. 370
- 1 coppia di tasselli di posizionamento precisi Art. 297
- 1 chiave a pipa Art. 375
- 1 piastrina di collegamento Art.801S

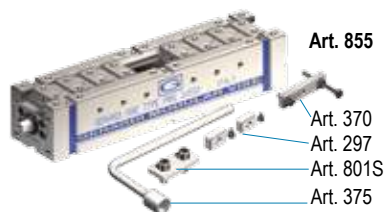
**Standard equipment:**

- 2 workstops Art. 370
- 1 pair of precision positioning key-nuts Art. 297
- 1 box wrench Art. 375
- 1 connecting plate Art.801S

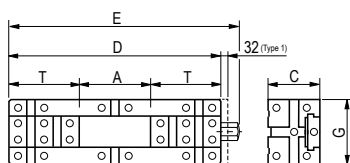
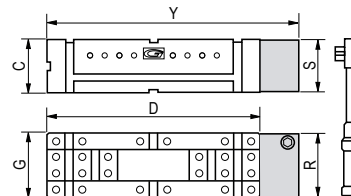
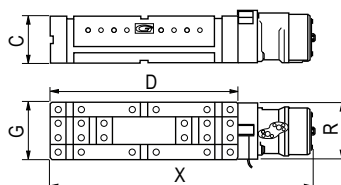
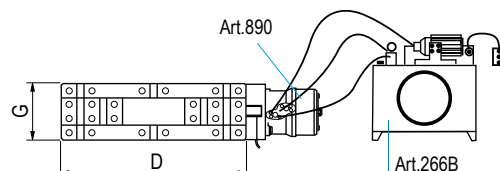
**Art. 855**

**Art. 855D**

**Art. 855E**

**Art. 855F**

3 30 kN			4 30 kN				5 32 kN			6 32 kN		
136	136	136	188	168	148	128	152	216	252	316	280	244
	100			120				140			160	
600	700	800	500	600	700	800	600	700	800	800	900	1000
625	725	825	525	625	725	825	625	725	825	825	925	1025
	125			145				170			190	
	124			144				169			189	
	99			119				139			159	
232	282	332	156	216	276	336	174	242	274	242	310	378
670	770	870	570	670	770	870	-	-	-	-	-	-
837	937	1037	737	837	937	1037	837	937	1037	1037	1137	1237
50	55	60	66	72	80	88	115	125	135	170	190	210
5.85.53600	5.85.53700	5.85.53800	5.85.54500	5.85.54600	5.85.54700	5.85.54800	5.85.55600	5.85.55700	5.85.55800	5.85.56800	5.85.56900	5.85.56100

**Art. 855D**

(Art. 855 + 802) Morsa + moltiplicatore di coppia / Vise + torque multiplier

5.85.5D360	5.85.5D370	5.85.5D380	5.85.5D450	5.85.5D460	5.85.5D470	5.85.5D480	5.85.5D560	5.85.5D570	5.85.5D580	5.85.5D680	5.85.5D690	5.85.5D610
------------	------------	------------	------------	------------	------------	------------	------------	------------	------------	------------	------------	------------

**Art. 802**

Moltiplicatore di coppia con rinvio angolare - Mechanical with torque multiplier with angular transmission

5.80.23000	5.80.24000	5.80.25000	5.80.26000
------------	------------	------------	------------

**Art. 855E**

(Art. 855 + 890) Morsa + motore idraulico / Vise + hydraulic motor

5.85.5E360	5.85.5E370	5.85.5E380	5.85.5E450	5.85.5E460	5.85.5E470	5.85.5E480	5.85.5E560	5.85.5E570	5.85.5E580	5.85.5E680	5.85.5E690	5.85.5E610
------------	------------	------------	------------	------------	------------	------------	------------	------------	------------	------------	------------	------------

Mechanical with prepared hydraulic connection complete with motor plate, bushing and proximity switch

**Art. 855F**

(Art. 855 + 890 + 266B) Morsa + motore idraulico + centralina / Vise + hydraulic motor + power unit

5.85.5F360	5.85.5F370	5.85.5F380	5.85.5F450	5.85.5F460	5.85.5F470	5.85.5F480	5.85.5F560	5.85.5F570	5.85.5F580	5.85.5F680	5.85.5F690	5.85.5F610
------------	------------	------------	------------	------------	------------	------------	------------	------------	------------	------------	------------	------------

Mechanical with elettrohydraulic power-pack ready to work

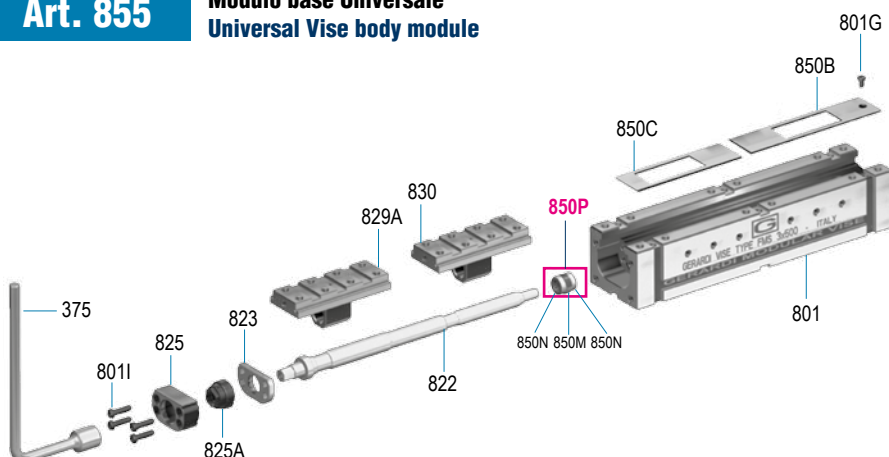
**Art. 855**
**Modulo base Universale**  
**Universal Vise body module**

Art.	Pag.
375	4.31
801	5.46
801G	5.61
8011	5.61
822	5.52
823	5.59
825	5.59
825A	5.61
829A	5.50
830	5.50
850B	5.61

Art.	Pag.
850C	5.61
850P	5.61
-	-
-	-
-	-
-	-
-	-
-	-
-	-
-	-
-	-

Tipo (grandezza) morsa / Vise type (size)		1 25 kN		2 25 kN			3 30 kN			
kN										
Apertura massima / Maximum opening		A	2 x 16	2 x 66	2 x 54	2 x 104	2 x 154	2 x 204	2 x 74	2 x 124
<b>Art. 860</b>		B	25		30			40		
		C	70		90			100		
		D	232	332	300	400	500	600	400	500
		E	249	349	320	420	520	620	425	525
		G	75		95			125		
		J	56		64			84		
		W	74		94			124		
kg			9	12	22	29	35	42	44	49
Cod.			5.86.01200	5.86.01300	5.86.02300	5.86.02400	5.86.02500	5.86.02600	5.86.03400	5.86.03500



Morsa FMS doppia, singola, autocentrante con ganasce piane

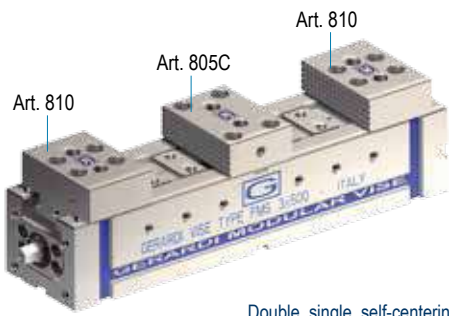

Double, single, self-centering FMS vise with straight jaws

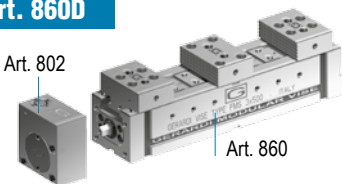
**Art. 860D**

(Art. 860 + 802) Morsa + moltiplicatore di coppia / Vise + torque multiplier

Cod.	5.86.0D120	5.86.0D130	5.86.0D230	5.86.0D240	5.86.0D250	5.86.0D260	5.86.0D340	5.86.0D350
------	------------	------------	------------	------------	------------	------------	------------	------------

**Art. 802**

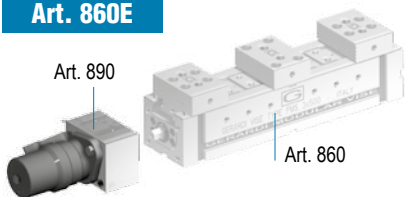

Moltiplicatore di coppia con rinvio angolare - Mechanical with torque multiplier with angular transmission

Cod.	5.80.21000	5.80.22000	5.80.23000
------	------------	------------	------------

**Art. 860E**

(Art. 860 + 890) Morsa + motore idraulico / Vise + hydraulic motor

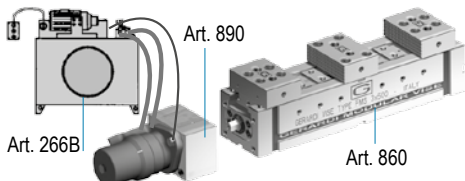
Cod.	5.86.0E120	5.86.0E130	5.86.0E230	5.86.0E240	5.86.0E250	5.86.0E260	5.86.0E340	5.86.0E350
------	------------	------------	------------	------------	------------	------------	------------	------------

**Art. 860F**

(Art. 860 + 890 + 266B) Morsa + motore idraulico + centralina / Vise + hydraulic motor + power unit

Cod.	5.86.0F120	5.86.0F130	5.86.0F230	5.86.0F240	5.86.0F250	5.86.0F260	5.86.0F340	5.86.0F350
------	------------	------------	------------	------------	------------	------------	------------	------------

**Dotazione standard:**

- 2 arresti laterali Art. 370
- 1 coppia di tasselli di posizionamento precisi Art. 297
- 1 chiave a pipa Art. 375
- 1 piastrina di collegamento Art.801S

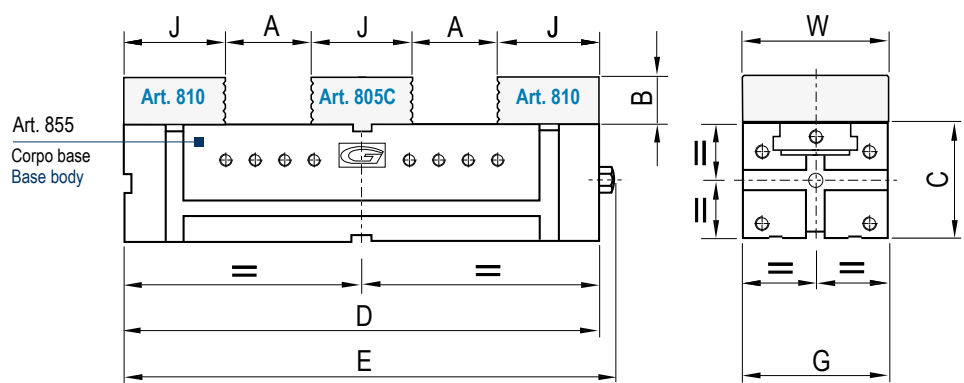
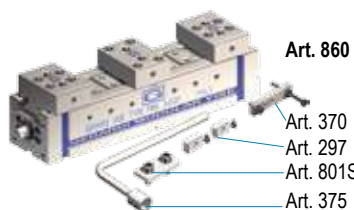
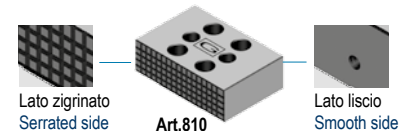
**Standard equipment:**

- 2 workstops Art. 370
- 1 pair of precision positioning key-nuts Art. 297
- 1 box wrench Art. 375
- 1 connecting plate Art.801S



3 30 kN			4 30 kN				5 32 kN			6 32 kN		
2 x 174	2 x 224	2 x 274	2 x 103	2 x 153	2 x 203	2 x 253	2 x 138	2 x 188	2 x 238	2 x 238	2 x 288	2 x 338
40			50				60			60		
100			120				140			160		
600	700	800	500	600	700	800	600	700	800	800	900	1000
625	725	825	525	625	725	825	625	725	825	825	925	1025
125			145				170			190		
84			98				108			108		
124			144				169			189		
54	59	64	71	79	88	96	130	140	150	210	230	250
5.86.03600	5.86.03700	5.86.03800	5.86.04500	5.86.04600	5.86.04700	5.86.04800	5.86.05600	5.86.05700	5.86.05800	5.86.06800	5.86.06900	5.86.06100

**Art. 860D**

(Art. 860 + 802) Morsa + moltiplicatore di coppia / Vise + torque multiplier

5.86.0D360	5.86.0D370	5.86.0D380	5.86.0D450	5.86.0D460	5.86.0D470	5.86.0D480	5.86.0D560	5.86.0D570	5.86.0D580	5.86.0D680	5.86.0D690	5.86.0D610
------------	------------	------------	------------	------------	------------	------------	------------	------------	------------	------------	------------	------------

**Art. 802**

Moltiplicatore di coppia con rinvio angolare - Mechanical with torque multiplier with angular transmission

5.80.23000	5.80.24000	5.80.25000	5.80.26000
------------	------------	------------	------------

**Art. 860E**

(Art. 860 + 890) Morsa + motore idraulico / Vise + hydraulic motor

5.86.0E360	5.86.0E370	5.86.0E380	5.86.0E450	5.86.0E460	5.86.0E470	5.86.0E480	5.86.0E560	5.86.0E570	5.86.0E580	5.86.0E680	5.86.0E690	5.86.0E610
------------	------------	------------	------------	------------	------------	------------	------------	------------	------------	------------	------------	------------

**Art. 860F**

(Art. 860 + 890 + 266B) Morsa + motore idraulico + centralina / Vise + hydraulic motor + power unit

5.86.0F360	5.86.0F370	5.86.0F380	5.86.0F450	5.86.0F460	5.86.0F470	5.86.0F480	5.86.0F560	5.86.0F570	5.86.0F580	5.86.0F680	5.86.0F690	5.86.0F610
------------	------------	------------	------------	------------	------------	------------	------------	------------	------------	------------	------------	------------

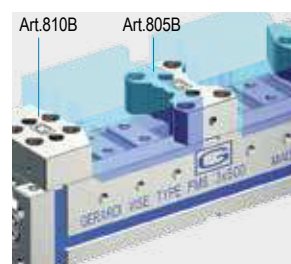
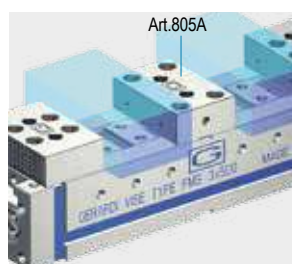
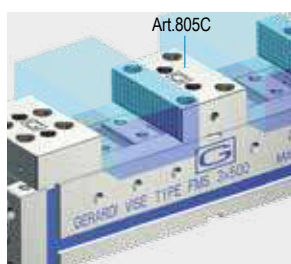
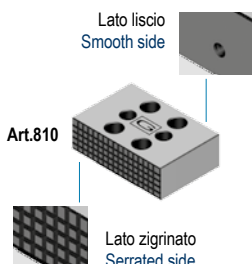
**Art. 860**
**Esempi applicativi ganasce:**  
**Jaw application examples:**



Art.	Pag.
<b>810</b>	5.56
<b>805C</b>	5.54
<b>805A</b>	5.54
<b>805B</b>	5.54
<b>810B</b>	5.56

 Ganasce Mobile reversibile  
 Reversible movable jaw

 Ganasce Zigrinate Art.805C  
 Serrated Jaw Art.805C

 Ganasce Liscie Art.805A  
 Smooth Jaw Art.805A

 Ganasce Lavorabili Art.805B + Art.810B  
 Soft Jaws Art.805B + Art.810B

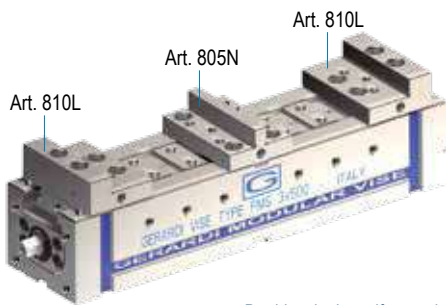
Tipo (grandezza) morsa / Vise type (size)		1 25 kN		2 25 kN			3 30 kN			
kN										
Apertura massima / Maximum opening		A	2 x 60	2 x 110	2 x 118	2 x 168	2 x 218	2 x 268	2 x 162	2 x 212
<b>Art. 863</b>		B	25		30			40		
		C	70		90			100		
Morsa FMS doppia, singola, autocentrante con ganasce a gradino		D	232	332	300	400	500	600	400	500
		E	249	349	320	420	520	620	425	525
Double, single, self-centering FMS vise with step jaws		G	75		95			125		
		J	56		64			84		
		J1	22		24			30		
		J2	16		16			16		
		W	74		94			124		
		kg	8	11	20	27	33	40	40	45
		Cod.	5.86.31200	5.86.31300	5.86.32300	5.86.32400	5.86.32500	5.86.32600	5.86.33400	5.86.33500

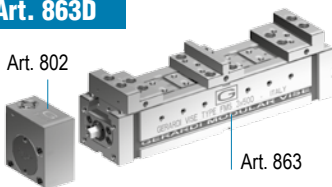
**Art. 863D**

(Art. 863 + 802) Morsa + moltiplicatore di coppia / Vise + torque multiplier

Cod. 5.86.3D120 5.86.3D130 5.86.3D230 5.86.3D240 5.86.3D250 5.86.3D260 5.86.3D340 5.86.3D350

**Art. 802**

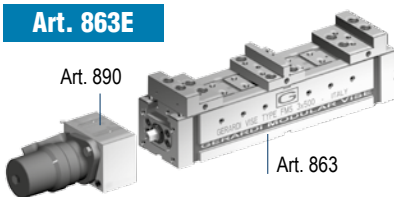

Moltiplicatore di coppia con rinvio angolare - Mechanical with torque multiplier with angular transmission

Cod. 5.80.21000 5.80.22000 5.80.23000

**Art. 863E**

(Art. 863 + 890) Morsa + motore idraulico / Vise + hydraulic motor

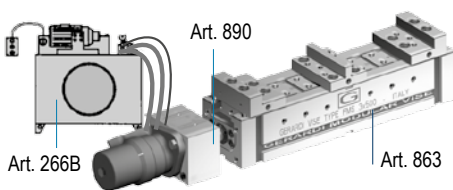
Cod. 5.86.3E120 5.86.3E130 5.86.3E230 5.86.3E240 5.86.3E250 5.86.3E260 5.86.3E340 5.86.3E350

**Art. 863F**

(Art. 863 + 890 + 266B) Morsa + motore idraulico + centralina / Vise + hydraulic motor + power unit

Cod. 5.86.3F120 5.86.3F130 5.86.3F230 5.86.3F240 5.86.3F250 5.86.3F260 5.86.3F340 5.86.3F350

**Dotazione standard:**

- 2 arresti laterali Art. 370
- 1 coppia di tasselli di posizionamento precisi Art. 297
- 1 chiave a pipa Art. 375
- 1 piastrina di collegamento Art.801S

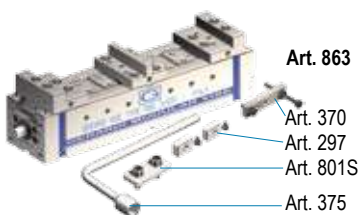
**Standard equipment:**

- 2 workstops Art. 370
- 1 pair of precision positioning key-nuts Art. 297
- 1 box wrench Art. 375
- 1 connecting plate Art.801S

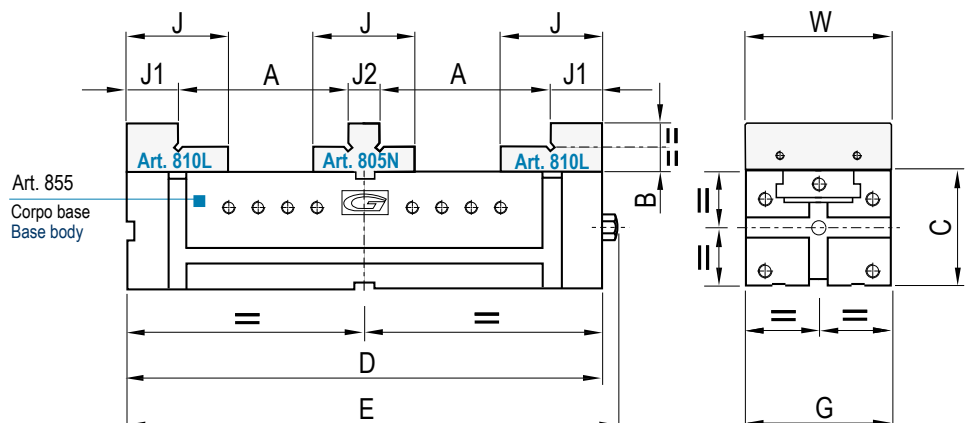

3 30 kN			4 30 kN				5 32 kN			6 32 kN		
2 x 262	2 x 312	2 x 362	2 x 204	2 x 254	2 x 304	2 x 354	2 x 254	2 x 304	2 x 354	2 x 354	2 x 404	2 x 454
40				50				60		60		
100				120				140		160		
600	700	800	500	600	700	800	600	700	800	800	900	1000
625	725	825	525	625	725	825	625	725	825	825	925	1025
125				145				170		190		
84				98				108		108		
30				38				38		38		
16				16				16		16		
124				144				169		189		
50	55	60	68	76	85	93	124	134	144	200	220	240
5.86.33600	5.86.33700	5.86.33800	5.86.34500	5.86.34600	5.86.34700	5.86.34800	5.86.35600	5.86.35700	5.86.35800	5.86.36800	5.86.36900	5.86.36100

**Art. 863D** (Art. 863 + 802) Morsa + moltiplicatore di coppia / Vise + torque multiplier

5.86.3D360	5.86.3D370	5.86.3D380	5.86.3D450	5.86.3D460	5.86.3D470	5.86.3D480	5.86.3D560	5.86.3D570	5.86.3D580	5.86.3D680	5.86.3D690	5.86.3D610
------------	------------	------------	------------	------------	------------	------------	------------	------------	------------	------------	------------	------------

**Art. 802** Moltiplicatore di coppia con rinvio angolare - Mechanical with torque multiplier with angular transmission

5.80.23000	5.80.24000	5.80.25000	5.80.26000
------------	------------	------------	------------

**Art. 863E** (Art. 863 + 890) Morsa + motore idraulico / Vise + hydraulic motor

5.86.3E360	5.86.3E370	5.86.3E380	5.86.3E450	5.86.3E460	5.86.3E470	5.86.3E480	5.86.3E560	5.86.3E570	5.86.3E580	5.86.3E680	5.86.3E690	5.86.3E610
------------	------------	------------	------------	------------	------------	------------	------------	------------	------------	------------	------------	------------

**Art. 863F** (Art. 863 + 890 + 266B) Morsa + motore idraulico + centralina / Vise + hydraulic motor + power unit

5.86.3F360	5.86.3F370	5.86.3F380	5.86.3F450	5.86.3F460	5.86.3F470	5.86.3F480	5.86.3F560	5.86.3F570	5.86.3F580	5.86.3F680	5.86.3F690	5.86.3F610
------------	------------	------------	------------	------------	------------	------------	------------	------------	------------	------------	------------	------------

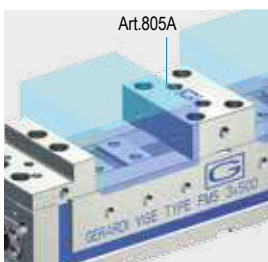
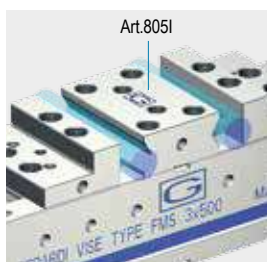
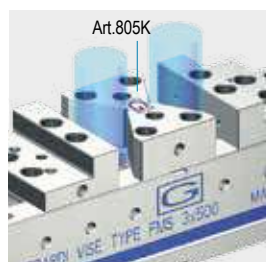
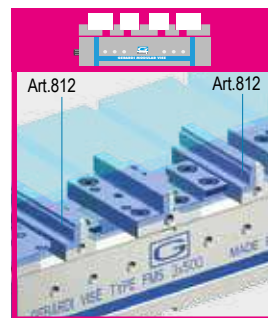
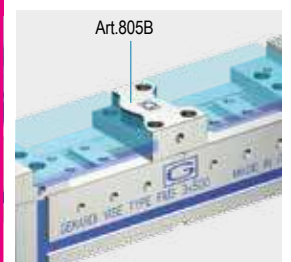
**Art. 863** Esempi applicativi ganasce: / Jaw application examples:

 Ganasce lisce  
 Smooth jaws

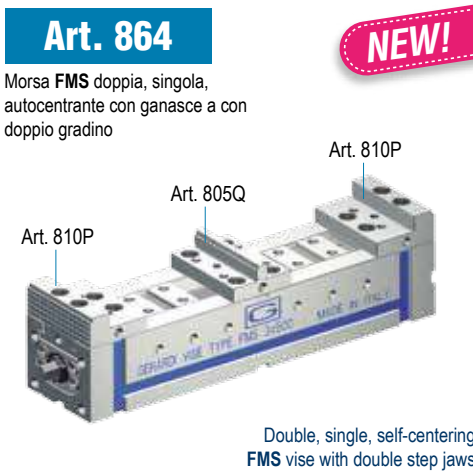
 Ganasca prismatica orizzontale  
 Horizontal prismatic jaws

 Ganasca prismatica verticale  
 Vertical prismatic jaw

 Serraggio simultaneo di 4 pezzi  
 4 Workpieces simultaneous clamping

 Ganasca lavorabile  
 Soft jaws

Tipo (grandezza) morsa / Vise type (size)		1 25 kN		2 25 kN			3 30 kN			
kN										
Apertura massima / Maximum opening		A	2 x 32	2 x 82	2 x 54	2 x 104	2 x 154	2 x 204	2 x 77	2 x 127
<b>Art. 864</b>		A1	2 x 84	2 x 134	2 x 118	2 x 168	2 x 218	2 x 268	2 x 162	2 x 212
		B	25		30			40		
		C	70		90			100		
		D	232	332	300	400	500	600	400	500
		E	249	349	320	420	520	620	425	525
		G	75		95			125		
		J	56		64			84		
		J1	24		24			30		
		J2	16		16			16		
		W	74		94			124		
kg			8	11	20	27	33	40	40	45
Cod.			5.86.41200	5.86.41300	5.86.42300	5.86.42400	5.86.42500	5.86.42600	5.86.43400	5.86.43500



<b>Art. 805F</b>		Cod.		5.80.5F100		5.80.5F200		5.80.5F300	
Ganascia fissa con doppio gradino 3x5 LISCIA									
Fixed jaw with double 3x5 step SMOOTH									

<b>Art. 805G</b>		Cod.		5.80.5G100		5.80.5G200		5.80.5G300	
Ganascia fissa con doppio gradino 3x5 ZIGRINATA									
Fixed jaw with double 3x5 step SERRATED									

<b>Art. 8100</b>		Cod.		5.81.00100		5.81.00200		5.81.00300	
Ganascia mobile con gradino piccolo e grande									
Movable jaw with small and large step									

<b>Art. 810X</b>		Cod.		5.81.0X100		5.81.0X200		5.81.0X300	
Ganascia mobile oscillante con gradino 3x5 zigrinata da un lato con albero a gradino (Art. 810Z)									
Floating movable jaw with 3x5 step one side serrated with step block pin (Art. 810Z)									

- Dotazione standard:**
- 2 arresti laterali Art. 370
  - 1 coppia di tasselli di posizionamento precisi Art. 297
  - 1 chiave a pipa Art. 375
  - 1 piastrina di collegamento Art.801S

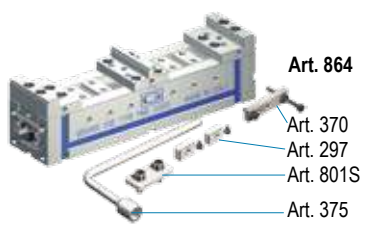

- Standard equipment:**
- 2 workstops Art. 370
  - 1 pair of precision positioning key-nuts Art. 297
  - 1 box wrench Art. 375
  - 1 connecting plate Art.801S

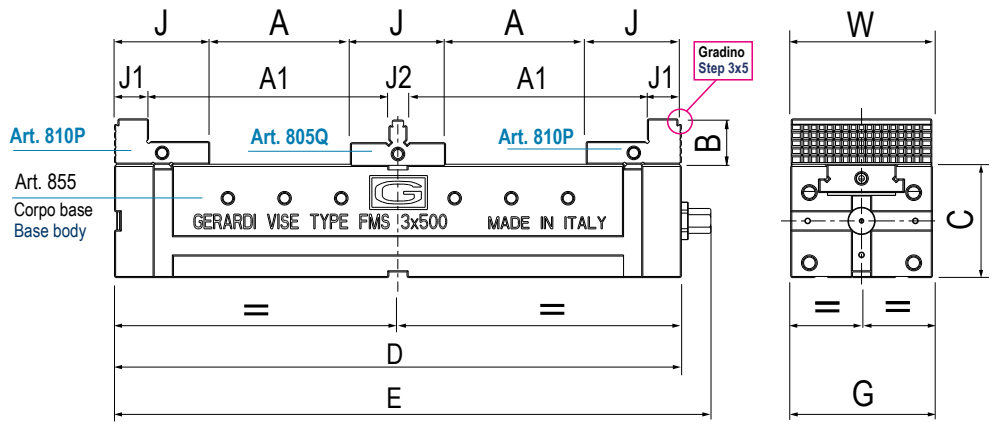



3 30 kN			4 30 kN				5 32 kN			6 32 kN		
2 x 177	2 x 227	2 x 277	2 x 103	2 x 153	2 x 203	2 x 253	2 x 138	2 x 188	2 x 238	2 x 238	2 x 288	2 x 338
2 x 262	2 x 312	2 x 362	2 x 204	2 x 254	2 x 304	2 x 354	2 x 254	2 x 304	2 x 354	2 x 354	2 x 404	2 x 454
40				50				60		60		
100				120				140		160		
600	700	800	500	600	700	800	600	700	800	800	900	1000
625	725	825	525	625	725	825	625	725	825	825	925	1025
125				145				170		190		
84				98				108		108		
30				38				38		38		
16				16				16		16		
124				144				169		189		
50	55	60	68	76	85	93	124	134	144	200	220	240
5.86.43600	5.86.43700	5.86.43800	5.86.44500	5.86.44600	5.86.44700	5.86.44800	5.86.45600	5.86.45700	5.86.45800	5.86.46800	5.86.46900	5.86.46100

**Art. 805F**

5.80.5F300

5.80.5F400

5.80.5F500

5.80.5F300

**Art. 805G**

5.80.5G300

5.80.5G400

5.80.5G500

**Art. 8100**

5.81.00300

5.81.00400

5.81.00500

5.81.00600

**Art. 810X**

5.81.0X300

5.81.0X400

5.81.0X500

5.81.0X600

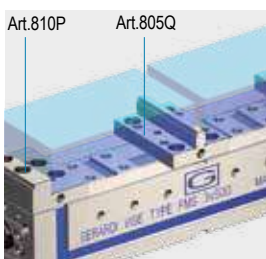
**Art. 864**
**Esempi applicativi ganasce a doppio gradino:  
 Double step jaw application examples:**

Utilizzo del gradino standard per alzare il particolare rispetto alla base  
 Use the main step for raising the workpiece

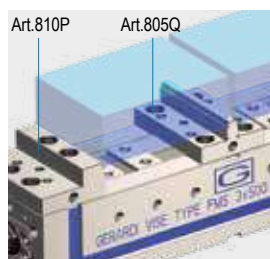

Per utilizzare il 2° gradino (3x5) ruotare le ganasce mobili di 180°  
 In order to use the second 3x5mm step turn the movable jaw 180°

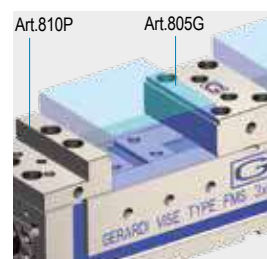

Per sfruttare il lato zigrinato delle ganasce mobili Art.810P sostituisci la ganascia fissa con l'Art.805G  
 To exploit the serrated side of the movable jaws Art.810P, change the fixed jaw with Art.805G

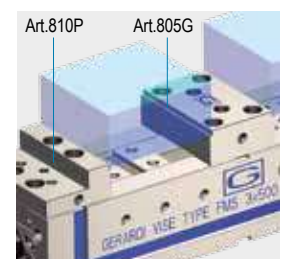

Tipo (grandezza) morsa / Vise type (size)		1		2			3		
kN		25 kN		25 kN			30 kN		
Apertura massima / Maximum opening		A	2 x 52	2 x 30	2 x 80	2 x 130	2 x 180	2 x 46	2 x 96
<b>Art. 865</b>		B	25	30			40		
		C	70	90			100		
		D	332	300	400	500	600	400	500
		E	349	320	420	520	620	425	525
		G	75	95			125		
		J	63	76			98		
		J1	70	88			111		
		W	74	94			124		
		kg	12	23	30	36	43	46	51
Cod.		5.86.51300	5.86.52300	5.86.52400	5.86.52500	5.86.52600	5.86.53400	5.86.53500	

**3 MORSE IN 1 VISES IN 1**

Morsa FMS doppia, singola, autocentrante con ganasce a cambio rapido discendente (sistema a pettine)

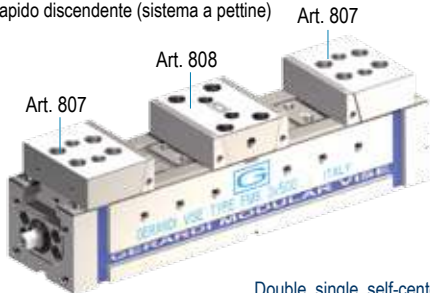

Double, single, self-centering FMS vise with quick change pull down jaws (comb system)

### Art. 865D

(Art. 865 + 802) Morsa + moltiplicatore di coppia / Vise + torque multiplier

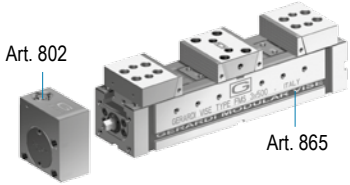

Cod.	5.86.5D130	5.86.5D230	5.86.5D240	5.86.5D250	5.86.5D260	5.86.5D340	5.86.5D350
------	------------	------------	------------	------------	------------	------------	------------

Moltiplicatore di coppia con rinvio angolare - Mechanical with torque multiplier with angular transmission

Cod.	5.80.21000	5.80.22000	5.80.23000
------	------------	------------	------------

### Art. 802



### Art. 865E

(Art. 865 + 890) Morsa + motore idraulico / Vise + hydraulic motor

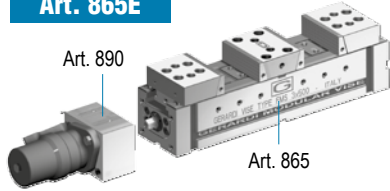

Cod.	5.86.5E130	5.86.5E230	5.86.5E240	5.86.5E250	5.86.5E260	5.86.5E340	5.86.5E350
------	------------	------------	------------	------------	------------	------------	------------

### Art. 865F

(Art. 865 + 890 + 266B) Morsa + motore idraulico + centralina / Vise + hydraulic motor + power unit

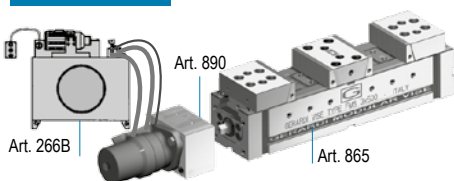

Cod.	5.86.5F130	5.86.5F230	5.86.5F240	5.86.5F250	5.86.5F260	5.86.5F340	5.86.5F350
------	------------	------------	------------	------------	------------	------------	------------

#### Dotazione standard:

- 2 arresti laterali Art. 370
- 1 coppia di tasselli di posizionamento precisi Art. 297
- 1 chiave a pipa Art. 375
- 1 piastrina di collegamento Art.801S

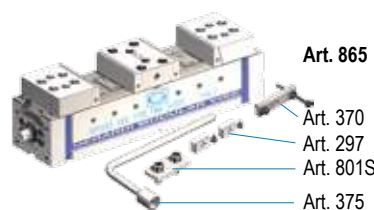

#### Standard equipment:

- 2 workstops Art. 370
- 1 pair of precision positioning key-nuts Art. 297
- 1 box wrench Art. 375
- 1 connecting plate Art.801S

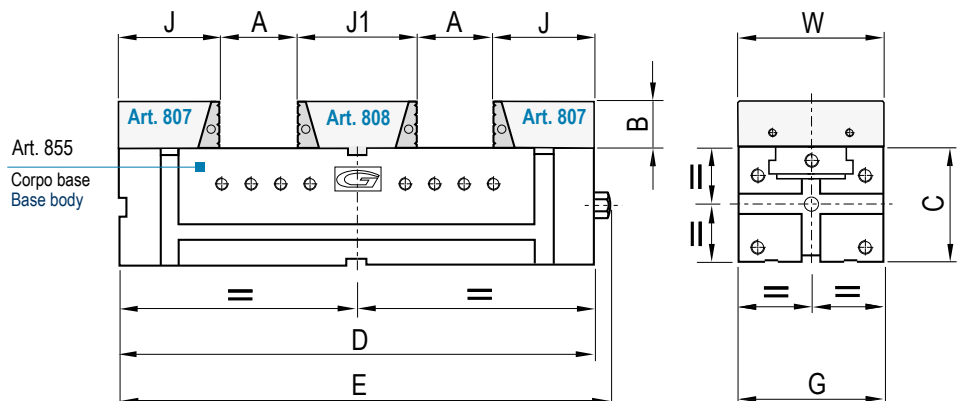

3 30 kN			4 30 kN				5 32 kN			6 32 kN		
2 x 146	2 x 196	2 x 246	2 x 65	2 x 115	2 x 165	2 x 215	2 x 90	2 x 140	2 x 190	2 x 216	2 x 256	2 x 316
40		50		60		60		60		60		
100		120		140		140		140		160		
600	700	800	500	600	700	800	600	700	800	800	900	1000
625	725	825	525	625	725	825	625	725	825	825	925	1025
125		145		170		170		170		190		
98		117		132		132		132		119		
111		136		155		155		155		130		
124		144		169		169		169		189		
54	59	64	74	82	91	99	134	144	154	215	235	255
5.86.53600	5.86.53700	5.86.53800	5.86.54500	5.86.54600	5.86.54700	5.86.54800	5.86.55600	5.86.55700	5.86.55800	5.86.56800	5.86.56900	5.86.56100

**Art. 865D**

(Art. 865 + 802) Morsa + moltiplicatore di coppia / Vise + torque multiplier

5.86.5D360	5.86.5D370	5.86.5D380	5.86.5D450	5.86.5D460	5.86.5D470	5.86.5D480	5.86.5D560	5.86.5D570	5.86.5D580	5.86.5D680	5.86.5D690	5.86.5D610
------------	------------	------------	------------	------------	------------	------------	------------	------------	------------	------------	------------	------------

**Art. 802**

Moltiplicatore di coppia con rinvio angolare - Mechanical with torque multiplier with angular transmission

5.80.23000

5.80.24000

5.80.25000

5.80.26000

**Art. 865E**

(Art. 865 + 890) Morsa + motore idraulico / Vise + hydraulic motor

5.86.5E360	5.86.5E370	5.86.5E380	5.86.5E450	5.86.5E460	5.86.5E470	5.86.5E480	5.86.5E560	5.86.5E570	5.86.5E580	5.86.5E680	5.86.5E690	5.86.5E610
------------	------------	------------	------------	------------	------------	------------	------------	------------	------------	------------	------------	------------

**Art. 865F**

(Art. 865 + 890 + 266B) Morsa + motore idraulico + centralina / Vise + hydraulic motor + power unit

5.86.5F360	5.86.5F370	5.86.5F380	5.86.5F450	5.86.5F460	5.86.5F470	5.86.5F480	5.86.5F560	5.86.5F570	5.86.5F580	5.86.5F680	5.86.5F690	5.86.5F610
------------	------------	------------	------------	------------	------------	------------	------------	------------	------------	------------	------------	------------

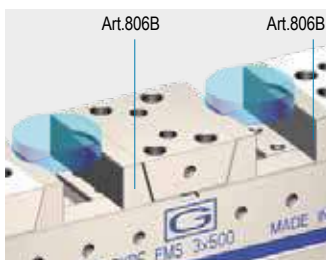
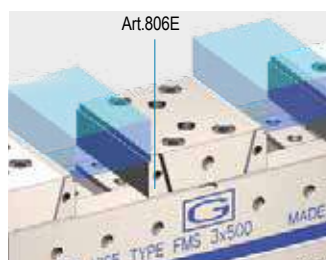
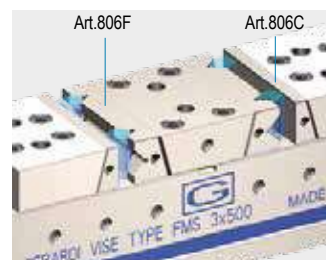
**Art. 865**
**Esempi applicativi piastre ganasce:**  
**Jaw plates application examples:**

 Piastre ganasce Art.806B  
 Jaw plates Art.806B

 4 Piastre ganasce Art.806E  
 4 Jaw plates Art.806E

 2 piastre ganasce Art.806F + 2 Art.806C  
 2 jaw plates Art.806F + 2 Art.806C

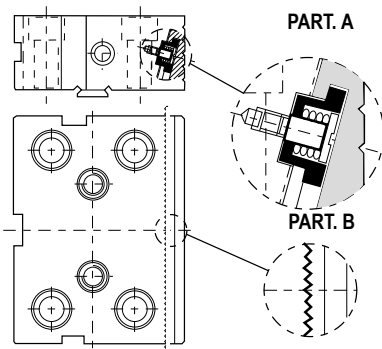
# CORPI GANASCE FMS & PIASTRE GANASCE INTERCAMBIABILI RAPIDE

## FMS COMB JAW BODIES & QUICK INTERCHANGEABLE JAW PLATES

Tipo (grandezza) / Vise type	1	2	3	4	5	6	
<b>Art. 806</b> Ganasce fissa con piastra ganasce intercambiabile rapida Fixed jaw with quick interchangeable jaw plate		Cod. 5.80.61000	5.80.62000	5.80.63000	5.80.64000	5.80.65000	5.80.66000
<b>Art. 807</b> Ganasce mobile con piastra ganasce intercambiabile rapida Movable jaw with quick interchangeable jaw plate		Cod. 5.80.71000	5.80.72000	5.80.73000	5.80.74000	5.80.75000	5.80.76000
<b>Art. 808</b> Ganasce fissa doppia con piastre ganasce intercambiabili rapide Double fixed jaw with quick interchangeable jaw plate		Cod. 5.80.81000	5.80.82000	5.80.83000	5.80.84000	5.80.85000	5.80.86000
<b>Art. 806A</b> Corpo ganasce fissa per piastra ganasce intercambiabile rapida Fixed jaw body for quick interchangeable jaw plate		Cod. 5.80.6A100	5.80.6A200	5.80.6A300	5.80.6A400	5.80.6A500	5.80.6A600
<b>Art. 807A</b> Corpo ganasce mobile per piastra ganasce intercambiabile rapida Movable jaw body for quick interchangeable jaw plate		Cod. 5.80.7A100	5.80.7A200	5.80.7A300	5.80.7A400	5.80.7A500	5.80.7A600
<b>Art. 808A</b> Corpo ganasce fissa doppia per piastre ganasce intercambiabili rapide Double fixed jaw body for quick interchangeable jaw plate		Cod. 5.80.8A100	5.80.8A200	5.80.8A300	5.80.8A400	5.80.8A500	5.80.8A600
<b>Art. 808B</b> Corpo ganasce fissa doppia ridotta per piastre ganasce intercambiabili rapide Double fixed jaw body narrow for quick interchangeable jaw plate		Cod. 5.80.8B100	5.80.8B200	5.80.8B300	5.80.8B400	5.80.8B500	5.80.8B600



### RAPIDA SOSTITUZIONE DELLE PIASTRE GANASCE DISCENDENTI SENZA BISOGNO DI ALCUN UTENSILE

Il nuovo sistema con piastre ganasce intercambiabili, conferisce alla morsa FMS un ulteriore aumento di flessibilità dato dalla rapidità di sostituzione delle piastre ganasce e dalla precisione di riposizionamento. La rapidità di sostituzione delle piastre ganasce è resa possibile dal nuovo sistema con perno a molla (PART. A), mentre le righe prismatiche (PART. B) effettuate con mola sagomata sui piani d'appoggio rendono possibile un riposizionamento di elevata precisione. La vasta gamma di piastre ganasce intercambiabili va a soddisfare le più svariate esigenze di lavorazione.

### QUICK HAND CHANGE OF PULL-DOWN JAW PLATES - NO TOOLS NEEDED

The new system with quick interchangeable jaw plates, increase the FMS vise flexibility, and feature the quick jaw plates replacement and their high precision repositioning. The quickness of the jaw plates replacement is allowed by the new system of pin with spring (PART. A), while the prismatic grooves (PART. B), made with shaped grind wheel on the surface plates, allow a perfect repositioning. The wide range of interchangeable jaws plates can satisfy the most varied working needs.

Piastra ganasce rapida **SINGOLA SPECIALE**  
**TAYLOR MADE SINGLE** quick change jaw plate

**PIASTRE RAPIDE** - Dimensioni speciali / **QUICK JAW PLATES** - Special dimensions

--	--	--	--	--	--	--

**Art. 806F**

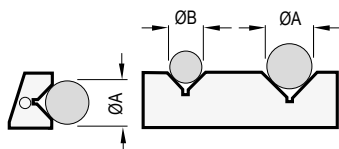

Piastra ganasce intercambiabile prismatica a pettine  
 Per serraggi autocentranti è necessario ordinare n. 2 piastrine prismatiche  
 Prismatic comb interchangeable jaw plate  
 For self-centering clamping is necessary to order n. 2 prismatic jaws

Ø Min / Max	A	6 / 16	9 / 24	13 / 38	15 / 40	15 / 42	15 / 42
B	4 / 10	7 / 18	9 / 24	9 / 24	9 / 24	9 / 24	9 / 24



# PIASTRE GANASCE INTERCAMBIABILI RAPIDE QUICK INTERCHANGEABLE JAW PLATES

Tipo (grandezza) / Vise type	1	2	3	4	5	6
W	73	93	123	143	168	188
B	25	30	40	50	60	60
C	10	10	11	11	16	16

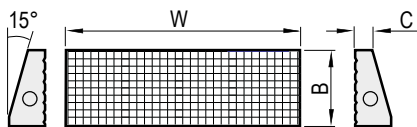

## Art. 806B

Piastra ganasce intercambiabile dolce a pettine  
Soft comb interchangeable jaw plate



Cod.	5.80.6B100	5.80.6B200	5.80.6B300	5.80.6B400	5.80.6B500	5.80.6B600
------	------------	------------	------------	------------	------------	------------

## Art. 806C

Piastra ganasce intercambiabile liscia a pettine  
Smooth comb interchangeable jaw plate



Cod.	5.80.6C100	5.80.6C200	5.80.6C300	5.80.6C400	5.80.6C500	5.80.6C600
------	------------	------------	------------	------------	------------	------------

## Art. 806D

Piastra ganasce intercambiabile zigrinata a pettine  
Serrated comb interchangeable jaw plate



Cod.	5.80.6D100	5.80.6D200	5.80.6D300	5.80.6D400	5.80.6D500	5.80.6D600
------	------------	------------	------------	------------	------------	------------

## Art. 806E \*

Piastra ganasce intercambiabile a gradino a pettine  
Step comb interchangeable jaw plate

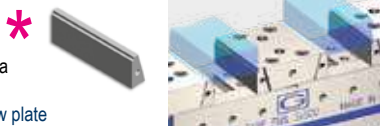

Cod.	5.80.6E100	5.80.6E200	5.80.6E300	5.80.6E400	5.80.6E500	5.80.6E600
------	------------	------------	------------	------------	------------	------------

## Art. 806F

Piastra ganasce intercambiabile prismatica a pettine  
Prismatic comb interchangeable jaw plate



<b>Solo 2 per morsa!! Just 2 pcs each vise!!</b>						
Cod.	5.80.6F100	5.80.6F200	5.80.6F300	5.80.6F400	5.80.6F500	5.80.6F600
Cad						
Each						

Vedi dimensioni prisma pag. 5.16 / See prisma dimensions pag. 5.16

## Art. 806G

Piastra ganasce intercambiabile a pettine con arresto a 90°  
90° interchangeable comb jaw plate



<b>Solo 2 per morsa!! Just 2 pcs each vise!!</b>						
Cod.	5.80.6G100	5.80.6G200	5.80.6G300	5.80.6G400	5.80.6G500	5.80.6G600

## Art. 806H

Piastra ganasce intercambiabile bombata a pettine  
Round comb interchangeable jaw plate



Cod.	5.80.6H100	5.80.6H200	5.80.6H300	5.80.6H400	5.80.6H500	5.80.6H600
------	------------	------------	------------	------------	------------	------------

## Art. 806M

Piastra ganasce intercambiabile a pettine per angolo di 30° o 45°  
30° or 45° angle interchangeable comb jaw plate

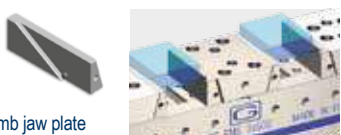

<b>Solo 2 per morsa!! Just 2 pcs each vise!!</b>						
Cod.	5.80.6M100	5.80.6M200	5.80.6M300	5.80.6M400	5.80.6M500	5.80.6M600

## Art. 806E \*

Piastra ganasce intercambiabile a gradino a pettine (SET di coppie)  
Step comb interchangeable jaw plate (SET of pair)

**KIT RISPARMIO  
SAVING KIT**

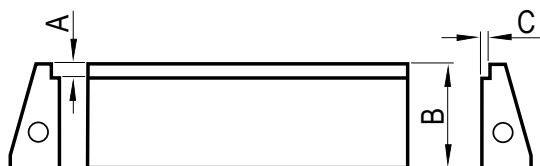

A	Set di 8 pezzi Set of 8 pcs.		Set di 10 pezzi Set of 10 pcs.		Set di 14 pezzi Set of 14 pcs.		Set di 14 pezzi Set of 14 pcs.		Set di 14 pezzi Set of 14 pcs.		Set di 14 pezzi Set of 14 pcs.	
	3	5	3	5	3	5	3	5	3	5	3	5
	8	13	8	13	8	13	8	13	8	13	8	13
	-	-	-	-	18	18	18	18	18	18	18	18
	-	-	-	-	-	23	23	23	23	23	23	23
	-	-	-	-	-	28	28	28	28	28	28	28
B	25	30	40	50	60	60						
C	3	3	3	3	3	3						
Cod.	5.80.6E112	5.80.6E212	5.80.6E312	5.80.6E412	5.80.6E512	5.80.6E612						

Tipo (grandezza) morsa / Vise type (size)		1		2			3		
kN		25 kN		25 kN			30 kN		
Apertura massima / Maximum opening		A	2 x 52	2 x 30	2 x 80	2 x 130	2 x 180	2 x 46	2 x 96
<b>Art. 866</b>		B	25	30			40		
		C	70	90			100		
Morsa FMS doppia, singola, autocentrante con ganasce oscillanti a gradino (3 x 5)		D	332	300	400	500	600	400	500
		E	349	320	420	520	620	425	525
Double, single, self-centering FMS vise with floating step jaws (3 x 5)		G	75	95			125		
		J	63	76			98		
		J1	70	88			111		
		W	74	94			124		
		kg	12	23	30	36	43	46	51
		Cod.	5.86.61300	5.86.62300	5.86.62400	5.86.62500	5.86.62600	5.86.63400	5.86.63500

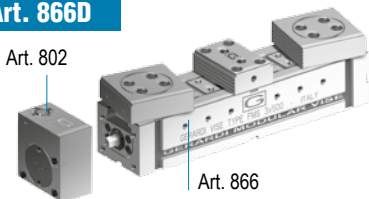
**Art. 866D**

(Art. 866 + 802) Morsa + moltiplicatore di coppia / Vise + torque multiplier

Cod.	5.86.6D130	5.86.6D230	5.86.6D240	5.86.6D250	5.86.6D260	5.86.6D340	5.86.6D350
------	------------	------------	------------	------------	------------	------------	------------

**Art. 802**

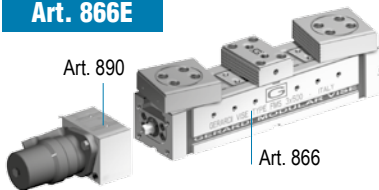

Moltiplicatore di coppia con rinvio angolare - Mechanical with torque multiplier with angular transmission

Cod.	5.80.21000	5.80.22000	5.80.23000
------	------------	------------	------------

**Art. 866E**

(Art. 866 + 890) Morsa + motore idraulico / Vise + hydraulic motor

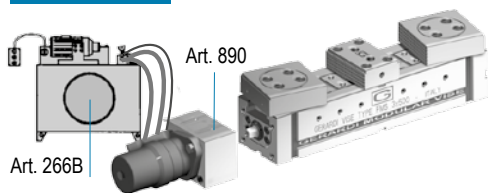
Cod.	5.86.6E130	5.86.6E230	5.86.6E240	5.86.6E250	5.86.6E260	5.86.6E340	5.86.6E350
------	------------	------------	------------	------------	------------	------------	------------

**Art. 866F**

(Art. 866 + 890 + 266B) Morsa + motore idraulico + centralina / Vise + hydraulic motor + power unit

Cod.	5.86.6F130	5.86.6F230	5.86.6F240	5.86.6F250	5.86.6F260	5.86.6F340	5.86.6F350
------	------------	------------	------------	------------	------------	------------	------------

**Dotazione standard:**

- 2 arresti laterali Art. 370
- 1 coppia di tasselli di posizionamento precisi Art. 297
- 1 chiave a pipa Art. 375
- 1 piastrina di collegamento Art.801S

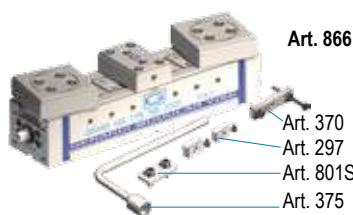
**Standard equipment:**

- 2 workstops Art. 370
- 1 pair of precision positioning key-nuts Art. 297
- 1 box wrench Art. 375
- 1 connecting plate Art.801S

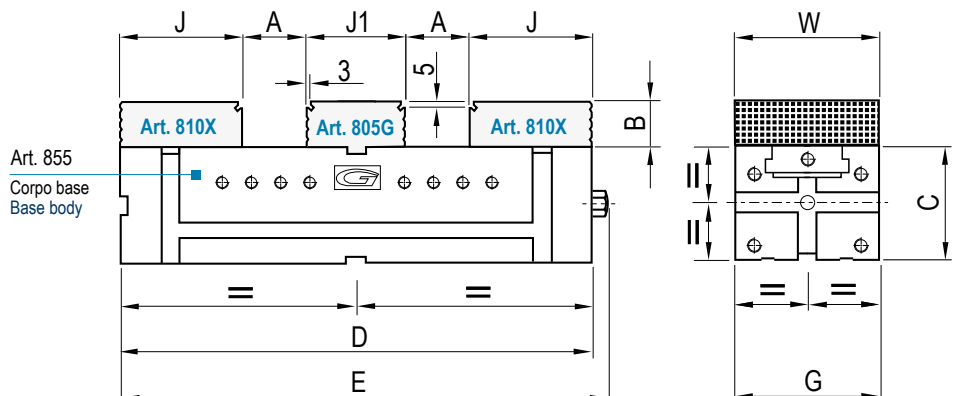

3 30 kN			4 30 kN				5 32 kN			6 32 kN		
2 x 152	2 x 202	2 x 252	2 x 73	2 x 123	2 x 173	2 x 223	2 x 111	2 x 161	2 x 211	2 x 203	2 x 235	2 x 303
40		50		60		60		60		60		
100		120		140		140		140		160		
600	700	800	500	600	700	800	600	700	800	800	900	1000
625	725	825	525	625	725	825	625	725	825	825	925	1025
125		145		170		170		170		190		
106		128		135		135		135		143		
84		98		108		108		108		108		
124		144		169		169		169		189		
54	59	64	74	82	91	99	134	144	154	215	235	255
5.86.63600	5.86.63700	5.86.63800	5.86.64500	5.86.64600	5.86.64700	5.86.64800	5.86.65600	5.86.65700	5.86.65800	5.86.66800	5.86.66900	5.86.66100

**Art. 866D**

(Art. 866 + 802) Morsa + moltiplicatore di coppia / Vise + torque multiplier

5.86.6D360	5.86.6D370	5.86.6D380	5.86.6D450	5.86.6D460	5.86.6D470	5.86.6D480	5.86.6D560	5.86.6D570	5.86.6D580	5.86.6D680	5.86.6D690	5.86.6D610
------------	------------	------------	------------	------------	------------	------------	------------	------------	------------	------------	------------	------------

**Art. 802**

Moltiplicatore di coppia con rinvio angolare - Mechanical with torque multiplier with angular transmission

5.80.23000	5.80.24000	5.80.25000	5.80.26000
------------	------------	------------	------------

**Art. 866E**

(Art. 866 + 890) Morsa + motore idraulico / Vise + hydraulic motor

5.86.6E360	5.86.6E370	5.86.6E380	5.86.6E450	5.86.6E460	5.86.6E470	5.86.6E480	5.86.6E560	5.86.6E570	5.86.6E580	5.86.6E680	5.86.6E690	5.86.6E610
------------	------------	------------	------------	------------	------------	------------	------------	------------	------------	------------	------------	------------

**Art. 866F**

(Art. 866 + 890 + 266B) Morsa + motore idraulico + centralina / Vise + hydraulic motor + power unit

5.86.6F360	5.86.6F370	5.86.6F380	5.86.6F450	5.86.6F460	5.86.6F470	5.86.6F480	5.86.6F560	5.86.6F570	5.86.6F580	5.86.6F680	5.86.6F690	5.86.6F610
------------	------------	------------	------------	------------	------------	------------	------------	------------	------------	------------	------------	------------

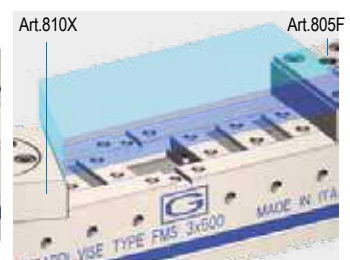
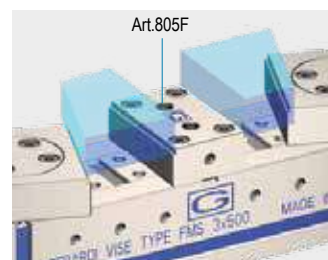
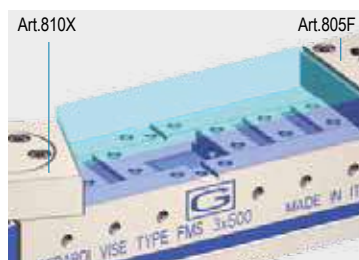
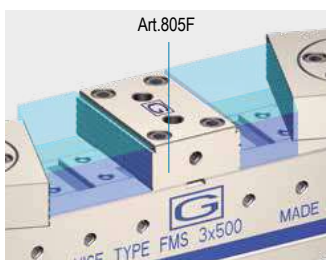
**Art. 866**
**Esempi applicativi ganasce oscillanti:  
 Floating Jaws application examples:**

Serraggio di particolari grezzi - Rough workpieces clamping

Serraggio particolari grezzi - Rough workpieces clamping

# FUNZIONAMENTO DELLE GANASCE MOBILI OSCILLANTI THE OPERATION OF MOVABLE JAWS

**3 MORSE IN  
VISES IN 1**

## Art. 810Z

Albero a gradino per ganasce mobili oscillanti  
Step block pin for floating movable jaw

## Art. 810W

Ganascia mobile oscillante zigrinata da un lato, con albero a gradino (Art. 810Z)  
Floating movable jaw one side serrated with step block pin (Art. 810Z)

Fig. 1 Pic. 1

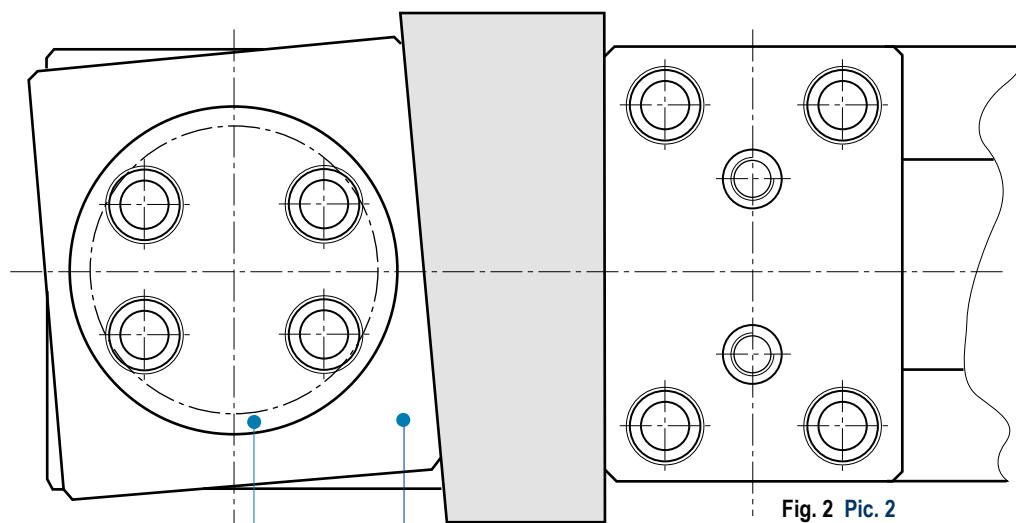
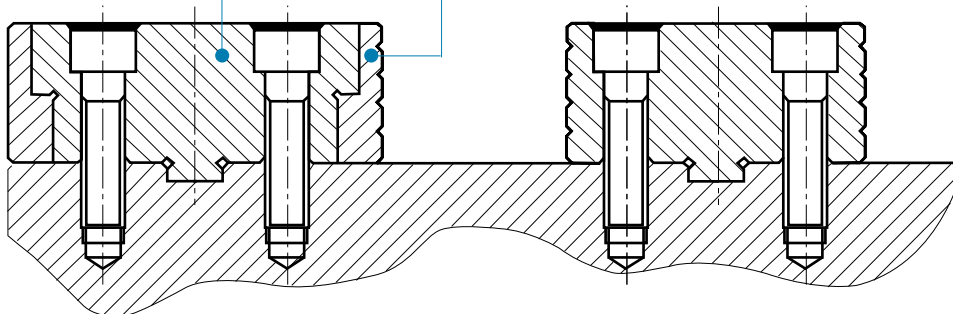

Fig. 2 Pic. 2

## Art. 810Z

Albero a gradino per ganasce mobili oscillanti  
Step block pin for floating movable jaw

## Art. 810W

Ganascia mobile oscillante zigrinata da un lato, con albero a gradino (Art. 810Z)  
Floating movable jaw one side serrated with step block pin (Art. 810Z)

Le ganasce mobili oscillanti consentono il serraggio di pezzi di forma irregolare i cui lati non risultino paralleli (Fig. 2). Questo è reso possibile dall'albero a gradino (Art. 810Z - Fig. 1), posto al centro della ganascia, che pur permettendo la rotazione della ganascia, ne mantiene la precisione ed evita il sollevamento del pezzo mentre viene lavorato. Il tutto a garanzia di un serraggio in piena sicurezza.

Floating movable jaws allow to clamp workpieces with irregular shapes whose sides are not parallel (Pic. 2). In fact thanks to the step block spindle (Art. 810Z - Pic. 1), positioned in the centre of the jaw body, the jaw can float and guarantee at the same time maximum precision and no tilting of the parts while being worked. The safety of the workholding is guaranteed.



# GANASCE MOBILI OSCILLANTI FLOATING MOVABLE JAWS

Tipo (grandezza) / Vise type (size)	1	2	3	4	5	6
<b>Art. 810W</b> Ganaschia mobile oscillante zigrinata da un lato con albero a gradino (Art. 810Z) Floating movable jaw one side serrated with step block pin (Art. 810Z)	Cod. 5.81.0W100	5.81.0W200	5.81.0W300	5.81.0W400	5.81.0W500	5.81.0W600
<b>Art. 810X</b> Ganaschia mobile oscillante con gradino 3x5 zigrinata da un lato con albero a gradino (Art. 810Z) Floating movable jaw with 3x5 step one side serrated with step block pin (Art. 810Z)	Cod. 5.81.0X100	5.81.0X200	5.81.0X300	5.81.0X400	5.81.0X500	5.81.0X600
<b>Art. 810Y</b> Ganaschia mobile oscillante con gradino 3x5 con albero a gradino (Art. 810Z) Floating movable jaw with 3x5 step with step block pin (Art. 810Z)	Cod. 5.81.0Y100	5.81.0Y200	5.81.0Y300	5.81.0Y400	5.81.0Y500	5.81.0Y600
<b>Art. 810Z</b> Albero a gradino per ganasce mobili oscillanti Step block pin for floating movable jaw	Cod. 5.81.0Z100	5.81.0Z200	5.81.0Z300	5.81.0Z400	5.81.0Z500	5.81.0Z600
<b>Art. 810WA</b> Corpo ganaschia mobile oscillante zigrinata da un lato Body floating movable jaw one side serrated	Cod. 5.81.0WA10	5.81.0WA20	5.81.0WA30	5.81.0WA40	5.81.0WA50	5.81.0WA60
<b>Art. 810XA</b> Corpo ganaschia mobile oscillante con gradino 3x5 zigrinata da un lato Body floating movable jaw with 3x5 step one side serrated	Cod. 5.81.0XA10	5.81.0XA20	5.81.0XA30	5.81.0XA40	5.81.0XA50	5.81.0XA60
<b>Art. 810YA</b> Corpo ganaschia mobile oscillante con gradino 3x5 Body floating movable jaw with 3x5 step	Cod. 5.81.0YA10	5.81.0YA20	5.81.0YA30	5.81.0YA40	5.81.0YA50	5.81.0YA60

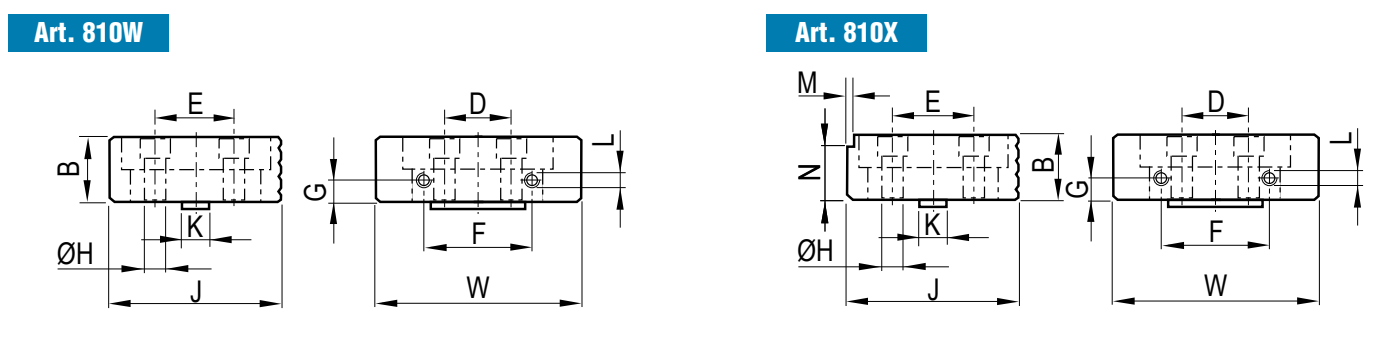

Tipo (grandezza) morsa / Vise (type) size	1	2	3	4	5	6	Tolleranze / Tolerance
mm							
B	25	30	40	50	60	60	- 0,02
D	20	25	38	48	44	54	-
E	32	40	50	60	68	68	-
F	40	50		65		100	-
G		10		20		25	-
H	9	11	13		17	22	-
L	M5			M6			-
K				16			H7
M				5			± 0,01
N				3			± 0,02
J	72	84	106	128	135	143	- 0,02
W	74	94	124	144	169	189	-

Tipo (grandezza) morsa / Vise type (size)

kN	1		2			3	
	25 kN		25 kN			30 kN	
A1	91	91	141	191	241	141	191
B	20		20			20	
C	70		90			100	
D	332	300	400	500	600	400	500
E	349	320	420	520	620	425	525
G	75		95			125	
J1	50		50			70	
J2	25		25			35	
Ø	30 (H = 16)		30 (H = 16)			30 (H = 16)	
W	100		120			170	
kg	11	20	27	33	40	40	45
Cod.	5.86.71300	5.86.72300	5.86.72400	5.86.72500	5.86.72600	5.86.73400	5.86.73500

**Art. 867**

Morsa FMS doppia, singola, autocentrante con ganasce oscillanti regolabili con inserti

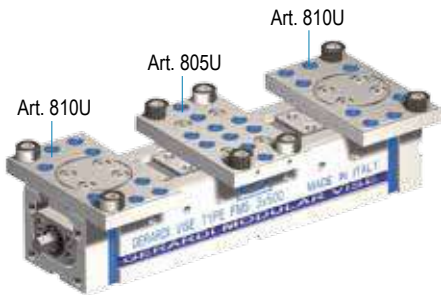
**3 MORSE IN 1**  
**VISES IN 1**

Double, single, self-centering FMS vise with floating adjustable jaws with inserts

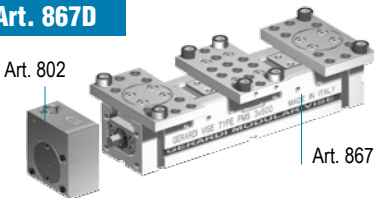
**Art. 867D**

(Art. 867 + 802) Morsa + moltiplicatore di coppia / Vise + torque multiplier

Cod.	5.86.7D130	5.86.7D230	5.86.7D240	5.86.7D250	5.86.7D260	5.86.7D340	5.86.7D350
------	------------	------------	------------	------------	------------	------------	------------

Moltiplicatore di coppia con rinvio angolare - Mechanical with torque multiplier with angular transmission

Cod.	5.80.21000	5.80.22000	5.80.23000
------	------------	------------	------------

**Art. 802**

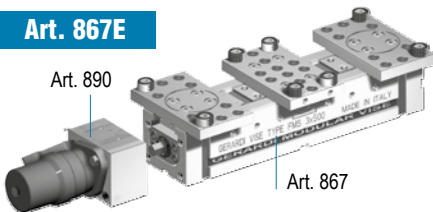
**Art. 867E**

(Art. 867 + 890) Morsa + motore idraulico / Vise + hydraulic motor

Cod.	5.86.7E130	5.86.7E230	5.86.7E240	5.86.7E250	5.86.7E260	5.86.7E340	5.86.7E350
------	------------	------------	------------	------------	------------	------------	------------

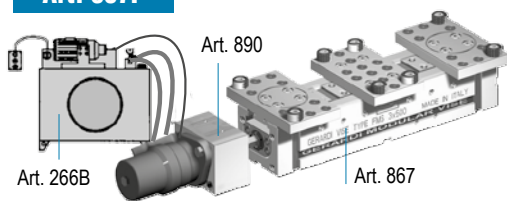
**Art. 867F**

(Art. 867 + 890 + 266B) Morsa + motore idraulico + centralina / Vise + hydraulic motor + power unit

Cod.	5.86.7F130	5.86.7F230	5.86.7F240	5.86.7F250	5.86.7F260	5.86.7F340	5.86.7F350
------	------------	------------	------------	------------	------------	------------	------------

**Dotazione standard:**

- 2 arresti laterali Art. 370
- 1 coppia di tasselli di posizionamento precisi Art. 297
- 1 chiave a pipa Art. 375
- 1 piastrina di collegamento Art.801S

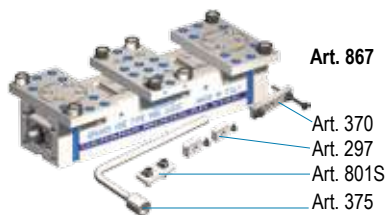
**Standard equipment:**

- 2 workstops Art. 370
- 1 pair of precision positioning key-nuts Art. 297
- 1 box wrench Art. 375
- 1 connecting plate Art.801S

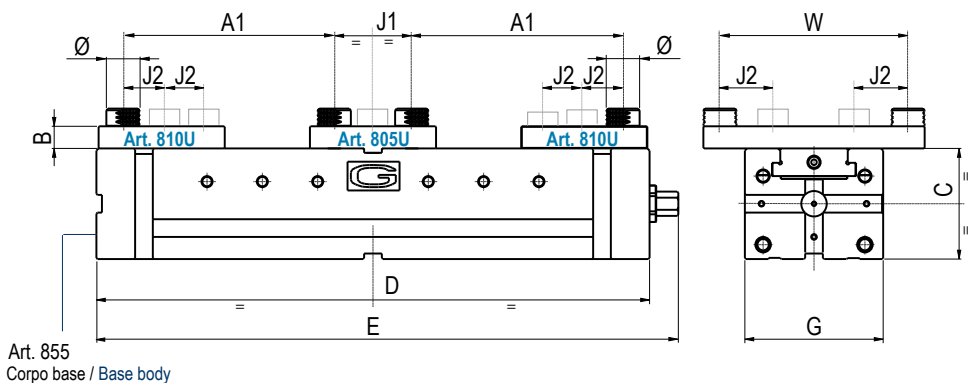

3 30 kN			4 30 kN				5 32 kN			6 32 kN		
241	291	341	191	241	291	341	231	281	331	331	381	431
20		30		35		35		100		160		
600	700	800	500	600	700	800	600	700	800	800	900	1000
625	725	825	525	625	725	825	625	725	825	825	925	1025
125		145		170		190		70		100		
35		40		40		40		30 (H = 16)		30 (H = 16)		
170		220		250		300		50		240		
50	55	60	68	76	85	93	124	134	144	200	220	240
5.86.73600	5.86.73700	5.86.73800	5.86.74500	5.86.74600	5.86.74700	5.86.74800	5.86.75600	5.86.75700	5.86.75800	5.86.76800	5.86.76900	5.86.76100

**Art. 867D** (Art. 867 + 802) Morsa + moltiplicatore di coppia / Vise + torque multiplier

5.86.7D360	5.86.7D370	5.86.7D380	5.86.7D450	5.86.7D460	5.86.7D470	5.86.7D480	5.86.7D560	5.86.7D570	5.86.7D580	5.86.7D680	5.86.7D690	5.86.7D610
------------	------------	------------	------------	------------	------------	------------	------------	------------	------------	------------	------------	------------

**Art. 802** Moltiplicatore di coppia con rinvio angolare - Mechanical with torque multiplier with angular transmission

5.80.23000	5.80.24000	5.80.25000	5.80.26000
------------	------------	------------	------------

**Art. 867E** (Art. 867 + 890) Morsa + motore idraulico / Vise + hydraulic motor

5.86.7E360	5.86.7E370	5.86.7E380	5.86.7E450	5.86.7E460	5.86.7E470	5.86.7E480	5.86.7E560	5.86.7E570	5.86.7E580	5.86.7E680	5.86.7E690	5.86.7E610
------------	------------	------------	------------	------------	------------	------------	------------	------------	------------	------------	------------	------------

**Art. 867F** (Art. 867 + 890 + 266B) Morsa + motore idraulico + centralina / Vise + hydraulic motor + power unit

5.86.7F360	5.86.7F370	5.86.7F380	5.86.7F450	5.86.7F460	5.86.7F470	5.86.7F480	5.86.7F560	5.86.7F570	5.86.7F580	5.86.7F680	5.86.7F690	5.86.7F610
------------	------------	------------	------------	------------	------------	------------	------------	------------	------------	------------	------------	------------

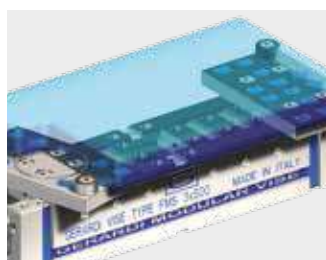
**Art. 867** Esempi applicativi ganasce oscillanti regolabili:  
 Floating adjustable jaws application examples:

4 inserti - 4 jaw inserts

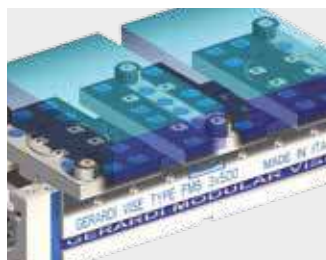

6 inserti - 6 jaw inserts

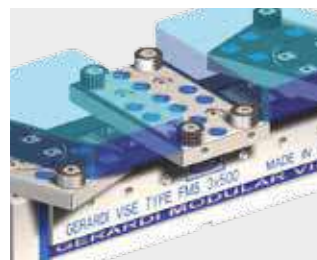

8 inserti - 8 jaw inserts

## FUNZIONAMENTO DELLE GANASCE MOBILI OSCILLANTI CON INSERTI HOW TO OPERATE FLOATING MOVABLE JAWS WITH INSERTS

**3 MORSE IN 1  
VISES IN 1**

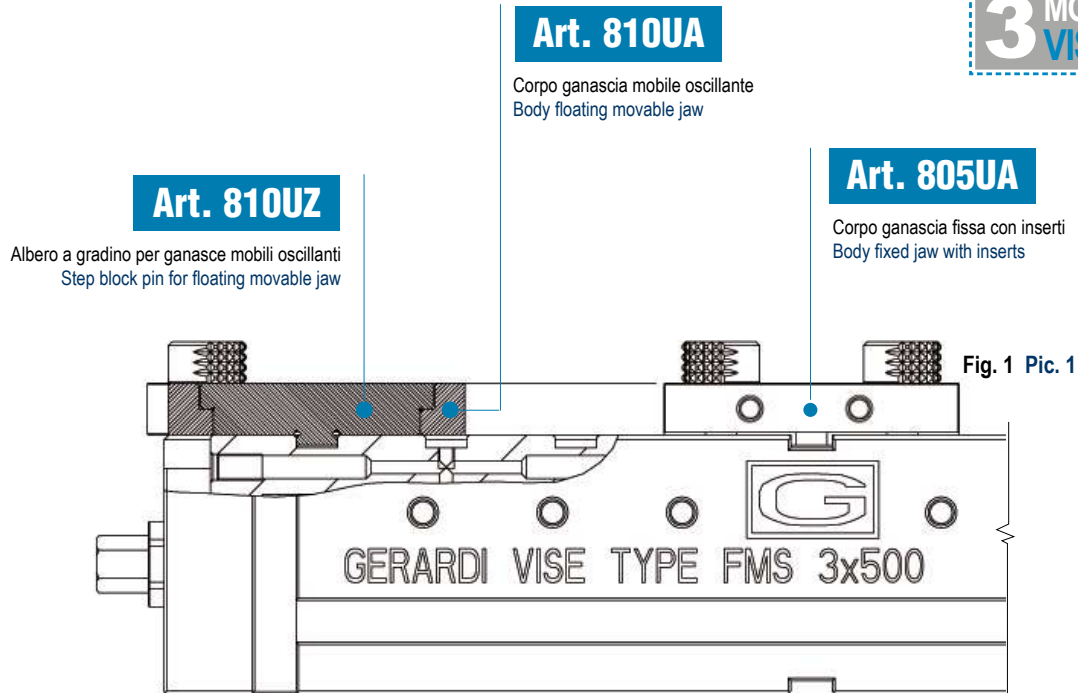

**Art. 812**

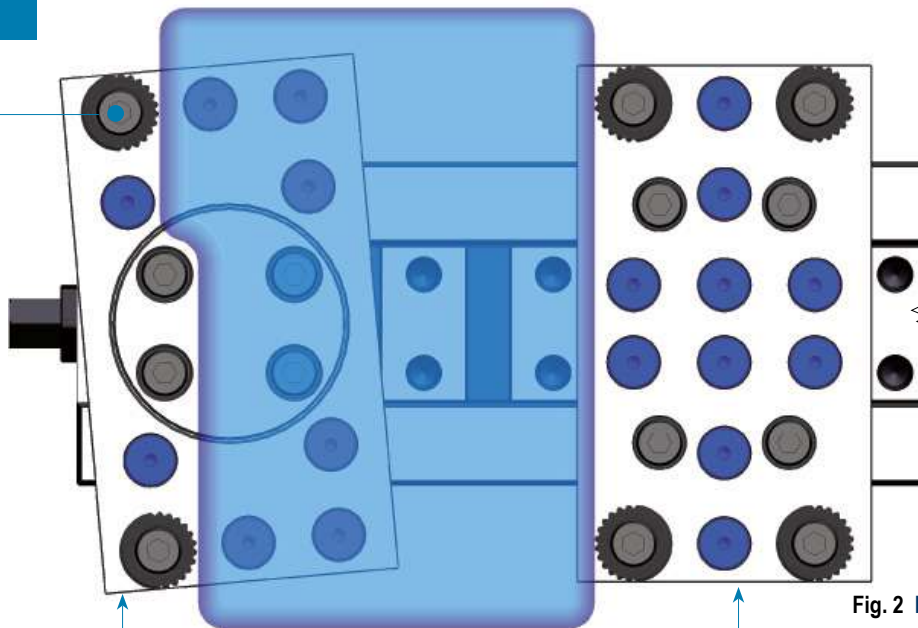

**Art. 810U**

Ganascia mobile oscillante con inserti  
Floating movable jaw with inserts

**Art. 805U**

Ganascia fissa con inserti  
Fixed jaw with inserts

Le ganasce mobili oscillanti consentono il serraggio di pezzi di forma irregolare i cui lati non risultino paralleli (Fig. 2). Questo è reso possibile dall'albero a gradino (Art. 810UZ - Fig. 1), posto al centro della ganascia, che pur permettendo la rotazione della ganascia, ne mantiene la precisione ed evita il sollevamento del pezzo mentre viene lavorato. Il tutto a garanzia di un serraggio in piena sicurezza. Gli inserti estremizzano ulteriormente la versatilità delle ganasce mobili oscillanti della morsa FMS.

Floating movable jaws allow to clamp workpieces with irregular shapes whose sides are not parallels (Pic. 2). In fact thanks to the step block spindle (Art. 810UZ - Pic. 1), positioned in the centre of the jaw body, the jaw can float and guarantee at the same time maximum precision and no tilting of the parts while being worked. The safety of the workholding is guaranteed. The insert further increase the versatility of the FMS floating movable jaws.

# GANASCE FISSE & MOBILI FMS

## FMS FIXED AND MOVABLE JAWS

Tipo (grandezza) morsa / Vise type (size)		1	2	3	4	5	6	
<b>Art. 810U</b>	Ganascia mobile oscillante con inserti Floating movable jaw with inserts		Cod. 5.81.0U100	5.81.0U200	5.81.0U300	5.81.0U400	5.81.0U500	5.81.0U600
<b>Art. 810UA</b>	Corpo ganascia mobile oscillante Body floating movable jaw		Cod. 5.81.0UA10	5.81.0UA20	5.81.0UA30	5.81.0UA40	5.81.0UA50	5.81.0UA60
<b>Art. 810UZ</b>	Albero a gradino per ganasce mobili oscillanti Step block pin for floating movable jaw		Cod. 5.81.0UZ10	5.81.0UZ20	5.81.0UZ30	5.81.0UZ40	5.81.0UZ50	5.81.0UZ60
<b>Art. 810Q</b>	Ganascia mobile con inserti Movable jaw with inserts		Cod. 5.81.0Q100	5.81.0Q200	5.81.0Q300	5.81.0Q400	5.81.0Q500	5.81.0Q600
<b>Art. 810QA</b>	Corpo ganascia mobile per inserti Body movable jaw for inserts		Cod. 5.81.0QA10	5.81.0QA20	5.81.0QA03	5.81.0QA40	5.81.0QA50	5.81.0QA60
<b>Art. 805U</b>	Ganascia fissa con inserti Fixed jaw with inserts		Cod. 5.80.5U100	5.80.5U200	5.80.5U300	5.80.5U400	5.80.5U500	5.80.5U600
<b>Art. 805UA</b>	Corpo ganascia fissa per inserti Body fixed jaw per inserts		Cod. 5.80.5UA10	5.80.5UA20	5.80.5UA30	5.80.5UA40	5.80.5UA50	5.80.5UA60
<b>Art. 812</b>	Coppia di inserti lisci e zigrinati Pair of smooth and serrated insert		Ø	30			40	
<b>Art. 812A</b>	Coppia di inserti lisci Pair of smooth insert		H	16			30	
<b>Art. 812C</b>	Coppia di inserti zigrinati Pair of serrated insert		Cod.	5.81.21000			5.81.25000	
			Cod.	5.81.2A100			5.81.2A500	
			Cod.	5.81.2C100			5.81.2C500	
<b>Art. 813</b>	Coppia di inserti lisci e zigrinati alti Pair of smooth and serrated high insert		Ø	30			40	
<b>Art. 813A</b>	Coppia di inserti lisci alti Pair of smooth high insert		H	28			50	
<b>Art. 813C</b>	Coppia di inserti zigrinati alti Pair of serrated high insert		Cod.	5.81.31000			5.81.35000	
			Cod.	5.81.3A100			5.81.3A500	
			Cod.	5.81.3C100			5.81.3C500	
<b>Art. 815</b>	Coppia di inserti lisci e zigrinati a gradino Pair of smooth and serrated step insert		H	16			30	
<b>Art. 815A</b>	Coppia di inserti lisci a gradino Pair of smooth step insert		Cod.	5.81.51000			5.81.55000	
<b>Art. 815C</b>	Coppia di inserti zigrinati a gradino Pair of serrated step insert		Cod.	5.81.5A100			5.81.5A500	
			Cod.	5.81.5C100			5.81.5C500	
<b>Art. 812B</b>	Coppia di inserti in acciaio lavorabile Pair of insert in machineable steel metal		Ø	40			60	
			H	40			60	
			Cod.	5.81.2B100			5.81.2B500	
<b>Art. 84U</b>	Tappo in alluminio Aluminum cap		Cod.	5.84.U1000			5.84.U5000	



Tipo (grandezza) morsa / Vise type (size)

**Art. 868**

 Morsa FMS autocentrante  
 (con opzione serraggi doppi o singoli)  
 con ganasce alte

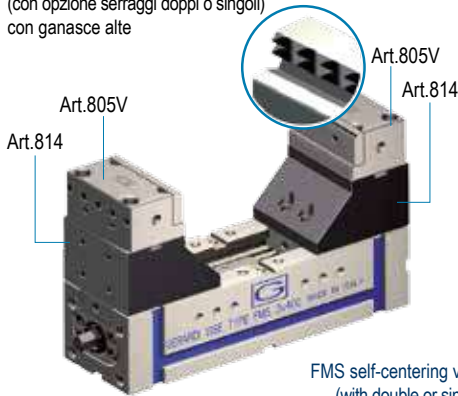
**3 MORSE IN 1**  
**VISES IN 1**

 FMS self-centering vise  
 (with double or single  
 clamping option) with high jaws

kN	1 25 kN		2 25 kN				3 30 kN	
	A	B	C	D	E	F	G	H
A	130	230	182	282	382	482	244	344
B	99,5			117			137	
C	70			90			100	
D	332	300	400	500	600	400	500	
E	349	320	420	520	620	425	525	
F	169,5			207			237	
G	75			95			125	
H	75			85			98	
L	56			64			84	
J3	76	76		101			132	
J4	55	55		63			82	
X	39,5			47			57	
W	74			94			124	
kg	-			-			-	

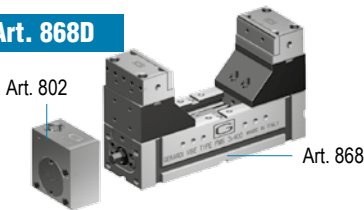
Cod. 5.86.81200 5.86.81300 5.86.82300 5.86.82400 5.86.82500 5.86.82600 5.86.83400 5.86.83500

**Art. 868D**

(Art. 868 + 802) Morsa + moltiplicatore di coppia / Vise + torque multiplier

Cod. 5.86.8D120 5.86.8D130 5.86.8D230 5.86.8D240 5.86.8D250 5.86.8D260 5.86.8D340 5.86.8D350

**Art. 802**

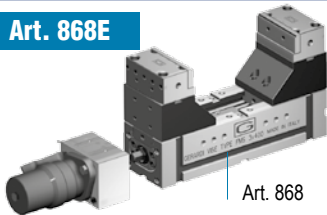

Moltiplicatore di coppia con rinvio angolare - Mechanical with torque multiplier with angular transmission

Cod. 5.80.21000 5.80.22000 5.80.23000

**Art. 868E**

(Art. 868 + 890) Morsa + motore idraulico / Vise + hydraulic motor

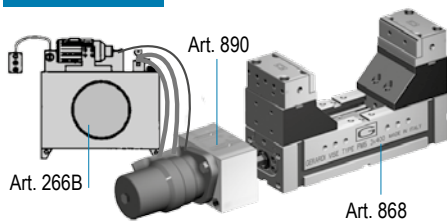
Cod. 5.86.8E120 5.86.8E130 5.86.8E230 5.86.8E240 5.86.8E250 5.86.8E260 5.86.8E340 5.86.8E350

**Art. 868F**

(Art. 868 + 890 + 266B) Morsa + motore idraulico + centralina / Vise + hydraulic motor + power unit

Cod. 5.86.8F120 5.86.8F130 5.86.8F230 5.86.8F240 5.86.8F250 5.86.8F260 5.86.8F340 5.86.8F350

**Dotazione standard:**

- 2 arresti laterali Art. 370
- 1 coppia di tasselli di posizionamento precisi Art. 297
- 1 chiave a pipa Art. 375
- 1 piastrina di collegamento Art. 801S

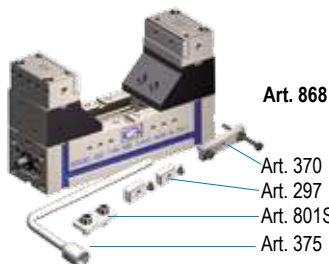
**Standard equipment:**

- 2 workstops Art. 370
- 1 pair of precision positioning key-nuts Art. 297
- 1 box wrench Art. 375
- 1 connecting plate Art. 801S

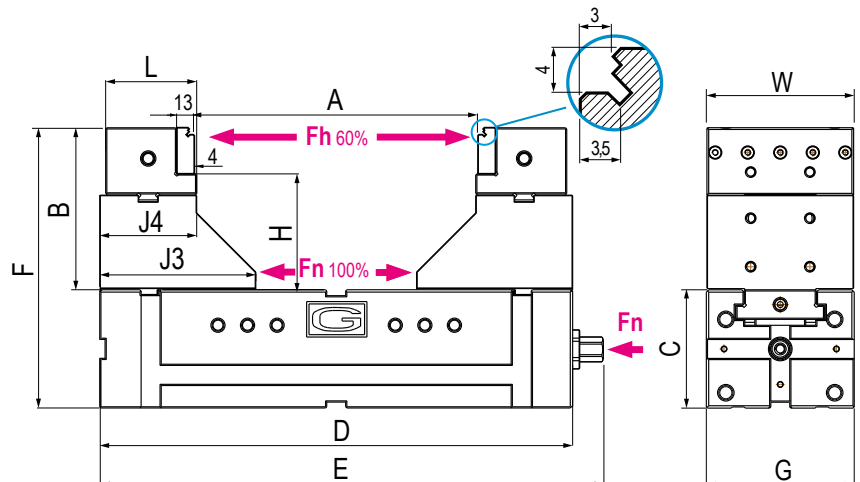

3 30 kN			4 30 kN				5 32 kN			6 32 kN		
444	544	644	316	416	516	616	396	496	596	596	696	796
	137			171				186			246	
	100			120				140			160	
600	700	800	500	600	700	800	600	700	800	800	900	1000
625	725	825	525	625	725	825	625	725	825	825	925	1025
	237			291				326			406	
	125			145				170			190	
	98			128				138			180	
	84			97				107			107	
	132			154				169			189	
	82			96				106			106	
	57			64				66			86	
	124			144				169			189	
	-			-				-			-	

5.86.83600	5.86.83700	5.86.83800	5.86.84500	5.86.84600	5.86.84700	5.86.84800	5.86.85600	5.86.85700	5.86.85800	5.86.86800	5.86.86900	5.86.86100
------------	------------	------------	------------	------------	------------	------------	------------	------------	------------	------------	------------	------------

**Art. 868D** (Art. 868 + 802) Morsa + moltiplicatore di coppia / Vise + torque multiplier

5.86.8D360	5.86.8D370	5.86.8D380	5.86.8D450	5.86.8D460	5.86.8D470	5.86.8D480	5.86.8D560	5.86.8D570	5.86.8D580	5.86.8D680	5.86.8D690	5.86.8D610
------------	------------	------------	------------	------------	------------	------------	------------	------------	------------	------------	------------	------------

**Art. 802** Moltiplicatore di coppia con rinvio angolare - Mechanical with torque multiplier with angular transmission

5.80.23000	5.80.24000	5.80.25000	5.80.26000
------------	------------	------------	------------

**Art. 868E** (Art. 868 + 890) Morsa + motore idraulico / Vise + hydraulic motor

5.86.8E360	5.86.8E370	5.86.8E380	5.86.8E450	5.86.8E460	5.86.8E470	5.86.8E480	5.86.8E560	5.86.8E570	5.86.8E580	5.86.8E680	5.86.8E690	5.86.8E610
------------	------------	------------	------------	------------	------------	------------	------------	------------	------------	------------	------------	------------

**Art. 868F** (Art. 868 + 890 + 266B) Morsa + motore idraulico + centralina / Vise + hydraulic motor + power unit

5.86.8F360	5.86.8F370	5.86.8F380	5.86.8F450	5.86.8F460	5.86.8F470	5.86.8F480	5.86.8F560	5.86.8F570	5.86.8F580	5.86.8F680	5.86.8F690	5.86.8F610
------------	------------	------------	------------	------------	------------	------------	------------	------------	------------	------------	------------	------------

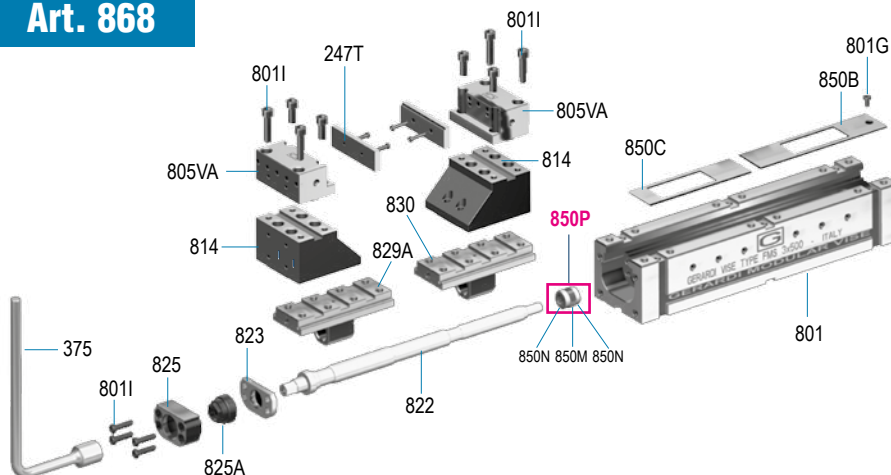
**Art. 868**

Art.	Pag.
375	4.31
801	5.46
801G	5.61
801I	5.61
810J	5.56
822	5.52
823	5.59
825	5.59
825A	5.61
829A	5.50
830	5.50

Art.	Pag.
850B	5.61
850C	5.61
850M	
850N	
850P	5.61
814	5.56
805VA	5.33
247T	5.33
-	-
-	-
-	-

## POSSIBILI COMBINAZIONI DELLA MORSA Art.868 POSSIBLE ARRANGEMENTS OF THE Art.868 VISE

Orientamento base mobile Art.814 per massima apertura ganasce  
Movable base Art.814 oriented for the maximum jaws opening

Orientamento base mobile Art.814 per chiusura ganasce a zero  
Movable base Art.814 oriented in order to close jaws completely

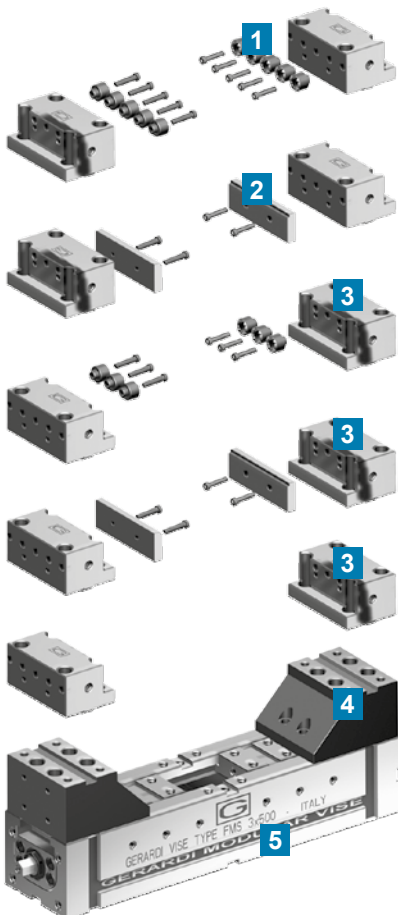
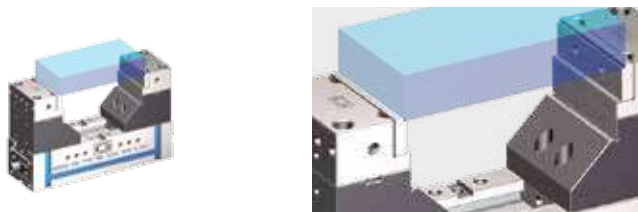
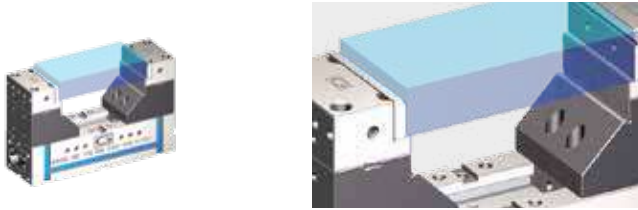

- |   |            |
|---|------------|
| 1 | Art. 90    |
| 2 | Art. 247T  |
| 3 | Art. 805VA |
| 4 | Art. 814   |
| 5 | Art. 855   |

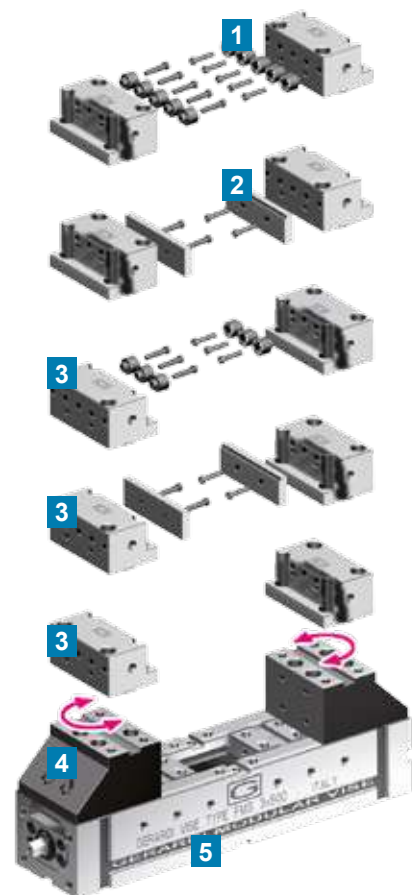

Possibilità di utilizzo di qualsiasi ganascia fissa FMS anziché del corpo ganascia 805V. Possibilità di due posizioni per ciascuna ganascia fissa e per base ganascia mobile Art.814  
Possibility to use each FMS fixed jaw instead of jaw body Art.805V. Possibility of two positions (at 180°) for each fixed jaw and for movable base jaw Art.814

# GANASCE & PIASTRE GANASCE PER Art.868

## JAWS & JAW PLATES FOR Art.868

Tipo (grandezza) / Type (size)	1	2	3	4	5	6
--------------------------------	---	---	---	---	---	---

### Art. 805V

Ganascia per piastrine e puntali  
 Jaw for plates and points



Cod.	5.80.5V100	5.80.5V200	5.80.5V300	5.80.5V400	5.80.5V500	5.80.5V600

### Art. 90

Inserto temprato GRIP  
 Hardened GRIP Insert



Cod.	5.90.10000					

### Art. 247T (W2)

Piastrina piana temprata GRIP  
 Hardened straight jaw plate GRIP

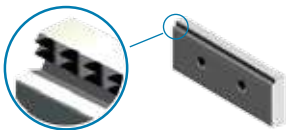

Cod.	4.24.7T100	4.24.7T200	4.24.7T300	4.24.7T400	4.24.7T500	4.24.7T600



**PIASTRE GANASCE "GRIP"**  
**Minor Superficie → Maggior Pressione**  
**Less Surface → More Pressure**

Per qualsiasi piastra piana speciale, raddoppiare il prezzo  
 For special I taylor made straight jaw plate double the price

### Art. 805VA

Corpo Ganascia  
 Jaw for plates and points

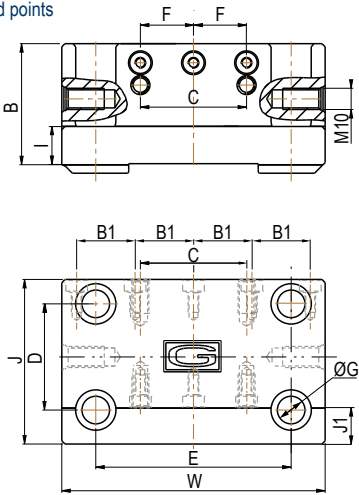

### Art. 247T

Piastrina piana temprata GRIP  
 Hardened straight jaw plate GRIP

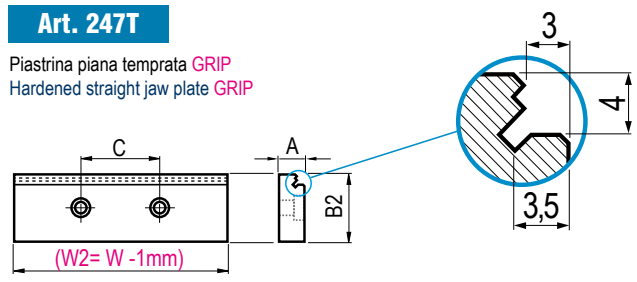

### Art. 90

Puntale temprato GRIP  
 Hardened GRIP Point

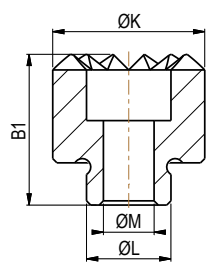

mm	1	2	3	4	5	6
W	74	94	124	144	169	189
A	12	12	13	13	18	
B	39,5	47	57	61	66	86
B1						
B2	24,5	32	39	43	48	56
C	25	32	50	50	75	90
D	32	40	50	60	68	68
E	56	70	92	108	126	144
F						
ØG	9	11	13	17	17	21
I	15	15	18	18	18	20
J	56	64	84	97	107	107
J1				17		
K	-			18		-
L	-			10 h8		-
M	-			6		-

Tipo (grandezza) morsa / Vise type (size)		1		2				3	
		25 kN		25 kN				30 kN	
		kN							
Apertura minima - massima / minimum - maximum Aperture	A	10 / 25	10 / 25	20 / 50	20 / 50	20 / 50	20 / 50	40 / 100	40 / 100
Apertura minima - massima / minimum - maximum Aperture	A1	10 / 15	10 / 15	10 / 25	10 / 25	10 / 25	10 / 25	25 / 50	25 / 50
<b>Art. 870</b>	B	34				55		90	
	C	70				90		100	
	D	232	332	300	400	500	600	400	500
	E	249	349	320	420	520	620	425	525
	F	104				145		190	
	G	75				95		125	
	J	48	60			102		132	
	W	50				75		100	
	kg	9	12	23	30	63	43	47	52
	Cod.	5.87.01200	5.87.01300	5.87.02300	5.87.02400	5.87.02500	5.87.02600	5.87.03400	5.87.03500

**3 MORSE IN VISES IN 1**

Morsa **FMS** autocentrante (opzione doppia o singola) con ganasce primatiche



FMS self-centering vise (double or single option) with prismatic jaws

### Art. 870D

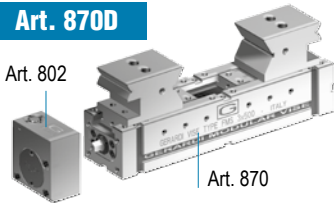

(Art. 870 + 802) Morsa + moltiplicatore di coppia / Vise + torque multiplier

Cod.	5.87.0D120	5.87.0D130	5.87.0D230	5.87.0D240	5.87.0D250	5.87.0D260	5.87.0D340	5.87.0D350
------	------------	------------	------------	------------	------------	------------	------------	------------

### Art. 802



Moltiplicatore di coppia con rinvio angolare - Mechanical with torque multiplier with angular transmission

Cod.	5.80.21000	5.80.22000	5.80.23000
------	------------	------------	------------

### Art. 870E

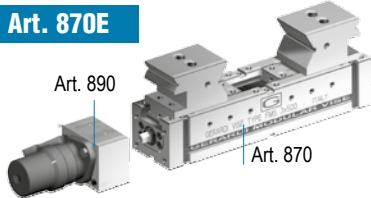

(Art. 870 + 890) Morsa + motore idraulico / Vise + hydraulic motor

Cod.	5.87.0E120	5.87.0E130	5.87.0E230	5.87.0E240	5.87.0E250	5.87.0E260	5.87.0E340	5.87.0E350
------	------------	------------	------------	------------	------------	------------	------------	------------

### Art. 870F

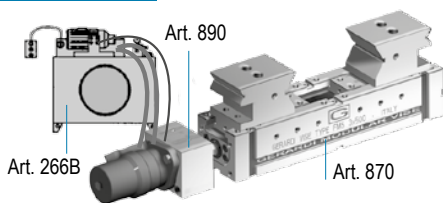

(Art. 870 + 890 + 266B) Morsa + motore idraulico + centralina / Vise + hydraulic motor + power unit

Cod.	5.87.0F120	5.87.0F130	5.87.0F230	5.87.0F240	5.87.0F250	5.87.0F260	5.87.0F340	5.87.0F350
------	------------	------------	------------	------------	------------	------------	------------	------------

#### Dotazione standard:

- 2 arresti laterali Art. 370
- 1 coppia di tasselli di posizionamento precisi Art. 297
- 1 chiave a pipa Art. 375
- 1 piastrina di collegamento Art.801S

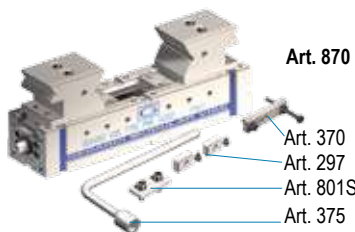

#### Standard equipment:

- 2 workstops Art. 370
- 1 pair of precision positioning key-nuts Art. 297
- 1 box wrench Art. 375
- 1 connecting plate Art.801S

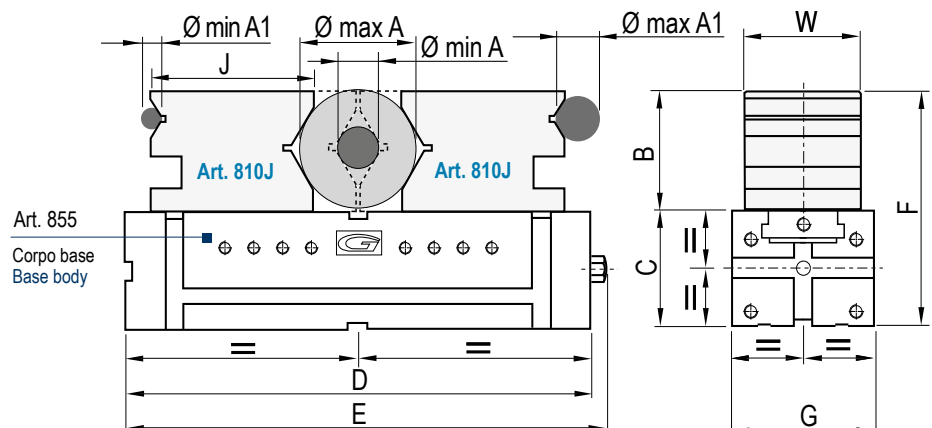



3 30 kN			4 30 kN				5 32 kN			6 32 kN		
40 / 100	40 / 100	40 / 100	40 / 150	40 / 150	40 / 150	40 / 150	63 / 200	65 / 240	80 / 280	100 / 300	120 / 350	140 / 400
25 / 50	25 / 50	25 / 50	30 / 60	30 / 60	30 / 60	30 / 60	35 / 70	35 / 70	35 / 80	40 / 140	40 / 140	40 / 140
90			132				171	191	226	250	275	300
100			120				140			160		
600	700	800	500	600	700	800	600	700	800	800	900	1000
625	725	825	525	625	725	825	625	725	825	825	925	1025
190			252				311	331	366	410	435	460
125			145				170			190		
132			156				176			174		
100			132				140			160		
57	62	67	74	82	91	99	135	145	155	225	245	265
5.87.03600	5.87.03700	5.87.03800	5.87.04500	5.87.04600	5.87.04700	5.87.04800	5.87.05600	5.87.05700	5.87.05800	5.87.06800	5.87.06900	5.87.06100

**Art. 870D**

(Art. 870 + 802) Morsa + moltiplicatore di coppia / Vise + torque multiplier

5.87.0D360 5.87.0D370 5.87.0D380 5.87.0D450 5.87.0D460 5.87.0D470 5.87.0D480 5.87.0D560 5.87.0D570 5.87.0D580 5.87.0D680 5.87.0D690 5.87.0D610

**Art. 802**

Moltiplicatore di coppia con rinvio angolare - Mechanical with torque multiplier with angular transmission

5.80.23000

5.80.24000

5.80.25000

5.80.26000

**Art. 870E**

(Art. 870 + 890) Morsa + motore idraulico / Vise + hydraulic motor

5.87.0E360 5.87.0E370 5.87.0E380 5.87.0E450 5.87.0E460 5.87.0E470 5.87.0E480 5.87.0E560 5.87.0E570 5.87.0E580 5.87.0E680 5.87.0E690 5.87.0E610

**Art. 870F**

(Art. 870 + 890 + 266B) Morsa + motore idraulico + centralina / Vise + hydraulic motor + power unit

5.87.0F360 5.87.0F370 5.87.0F380 5.87.0F450 5.87.0F460 5.87.0F470 5.87.0F480 5.87.0F560 5.87.0F570 5.87.0F580 5.87.0F680 5.87.0F690 5.87.0F610

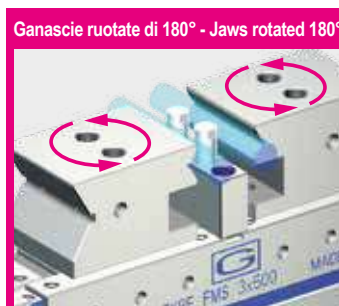
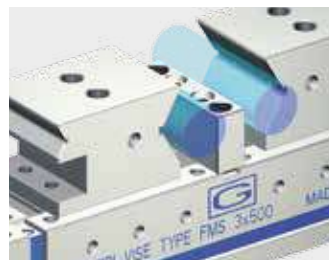
**Art. 870**
**Esempi applicativi ganasce prismatiche:**  
**Prismatic jaws application examples:**

Ganasce ruotate di 180° - Jaws rotated 180°

**Art. 870A**

 Serraggio di 2 particolari tondi per mezzo della ganascia intermedia alta Art.870A  
 Round workpieces clamping by intermediate high jaw Art.870A

Tipo (grandezza) morsa / Vise type (size)		1		2			3		
kN		25 kN		25 kN			30 kN		
Apertura massima / Maximum opening	A	85	185	170	270	370	470	230	330
Minima apertura interno-esterno / Minimum opening inside-outside	A1	115 / 200	115 / 300	130 / 300	130 / 400	130 / 500	130 / 600	170 / 400	170 / 500
	B	25		30			40		
	C	70		90			100		
	D	232	332	300	400	500	600	400	500
	E	249	349	320	420	520	620	425	525
	G	75		95			125		
	W	74		94			124		
	kg	7	10	18	25	32	39	40	45

### Art. 800

Morsa a Serraggio Meccanico solo per serraggi singoli

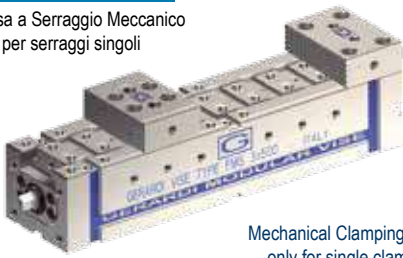

Mechanical Clamping vise only for single clamping

Cod. 5.80.01200 5.80.01300 5.80.02300 5.80.02400 5.80.02500 5.80.02600 5.80.03400 5.80.03500

**SPECIFICA SOLO PER SERRAGGI SINGOLI**

**SPECIFIC FOR SINGLE CLAMPING ONLY**

Questa morsa, pur essendo parte del programma FMS, non è predisposta per serraggi doppi o autocentranti

### Art. 800A

Meccanica con predisposizione idraulica solo per serraggi singoli / Mechanical with prepared hydraulic connection only for single clamping

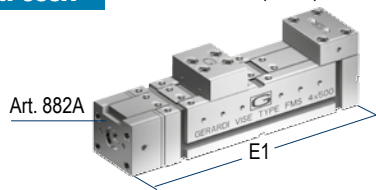

Art. 882A

E1

E1	273	373	370,5	470,5	570,5	670,5	485	585
Cod.	5.80.0A120	5.80.0A130	5.80.0A230	5.80.0A240	5.80.0A250	5.80.0A260	5.80.0A340	5.80.0A350

Connettore Idraulico - Hydraulic Connexion

Corsa - Stroke mm	4	7	10
Superficie - Surface cm <sup>2</sup>	6	21	21
Pressione - Pressure bar	417	119	143

### Art. 882A

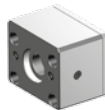

### Art. 800B

(Art. 800A + Art.393) Morsa + centralina a comando manuale singolo / Vise + power unit with single manual control

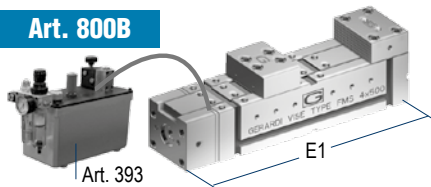

Art. 393

E1

E1	273	373	370,5	470,5	570,5	670,5	485	585
Cod.	5.80.0B120	5.80.0B130	5.80.0B230	5.80.0B240	5.80.0B250	5.80.0B260	5.80.0B340	5.80.0B350

### Art. 800D

(Art. 800 + 802) Morsa + moltiplicatore di coppia / Vise + torque multiplier

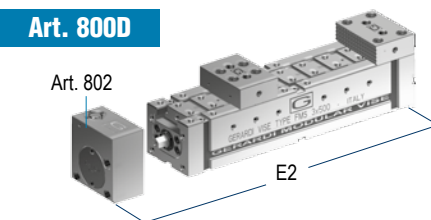

Art. 802

E2

E2	277	377	360	460	560	660	470	570
Nm	Max 20		Max 25			Max 20		
Cod.	5.80.0D120	5.80.0D130	5.80.0D230	5.80.0D240	5.80.0D250	5.80.0D260	5.80.0D340	5.80.0D350

Moltiplicatore di coppia con rinvio angolare - Mechanical with torque multiplier with angular transmission

Cod.	5.80.21000	5.80.22000	5.80.23000
------	------------	------------	------------

### Art. 802



#### Dotazione standard:

- 1 arresto laterale Art. 370
- 1 coppia di tasselli di posizionamento precisi Art. 297
- 1 chiave a pipa Art. 375

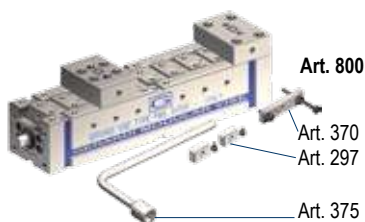

Art. 800

Art. 370

Art. 297

Art. 375

#### Standard equipment:

- 1 workstop Art. 370
- 1 pair of precision positioning key-nuts Art. 297
- 1 box wrench Art. 375

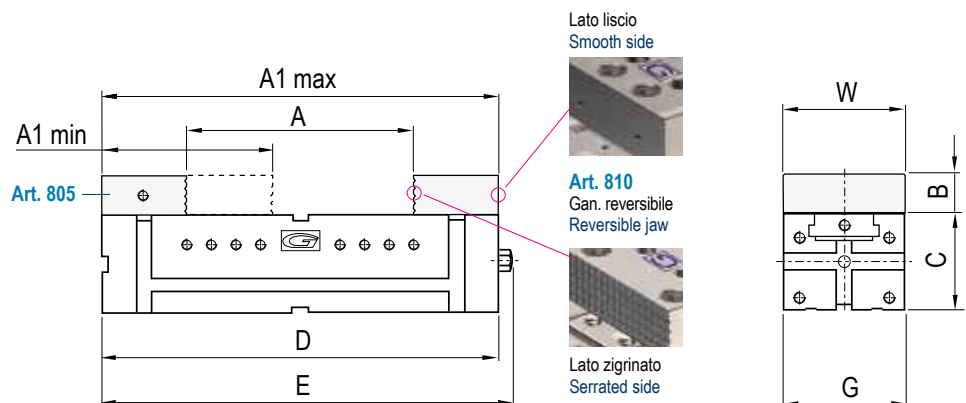

3 30 kN			4 30 kN				5 32 kN			6 32 kN		
430	530	630	300	400	500	600	380	480	580	580	680	780
170 / 600	170 / 700	170 / 800	200 / 500	200 / 600	200 / 700	200 / 800	220 / 600	220 / 700	220 / 800	220 / 800	220 / 800	220 / 100
40				50				60		60		
100				120				140		160		
600	700	800	500	600	700	800	600	700	800	800	900	1000
625	725	825	525	625	725	825	625	725	825	825	925	1025
125				145				170		190		
124				144				169		189		
50	55	60	66	72	80	88	115	125	135	170	190	210

5.80.03600 5.80.03700 5.80.03800 5.80.04500 5.80.04600 5.80.04700 5.80.04800 5.80.05600 5.80.05700 5.80.05800 5.80.06800 5.80.06900 5.80.06100

This type of vise even if it is part of the FMS series is not suitable for double or self-centering clamping

**Art. 800A**

Meccanica con predisposizione idraulica solo per serraggi singoli / Mechanical with prepared hydraulic connection only for single clamping

685	785	885	585	685	785	885	-	-	-	-	-	-
5.80.0A360	5.80.0A370	5.80.0A380	5.80.0A450	5.80.0A460	5.80.0A470	5.80.0A480	5.80.0A560	5.80.0A570	5.80.0A580	5.80.0A680	5.80.0A690	5.80.0A610

**Art. 882A**

Connettore Idraulico - Hydraulic Connexion

10				10				-			-	
21				21				-			-	
143				143				-			-	

**Art. 800B**

(Art. 800A + Art.393) Morsa + centralina a comando manuale singolo / Vise + power unit with single manual control

685	785	885	585	685	785	885	-	-	-	-	-	-
5.80.0B360	5.80.0B370	5.80.0B380	5.80.0B450	5.80.0B460	5.80.0B470	5.80.0B480	5.80.0B560	5.80.0B570	5.80.0B580	5.80.0B680	5.80.0B690	5.80.0B610

**Art. 800D**

(Art. 800 + 802) Morsa + moltiplicatore di coppia / Vise + torque multiplier

670	770	870	570	670	770	870	685	785	885	-	-	-	
Max 20			Max 20			Max 20			Max 20				
5.87.0D360	5.87.0D370	5.87.0D380	5.87.0D450	5.87.0D460	5.87.0D470	5.87.0D480	5.87.0D560	5.87.0D570	5.87.0D580	5.87.0D680	5.87.0D690	5.87.0D610	

**Art. 802**

Moltiplicatore di coppia con rinvio angolare - Mechanical with torque multiplier with angular transmission

5.80.23000

5.80.24000

5.80.25000

5.80.26000

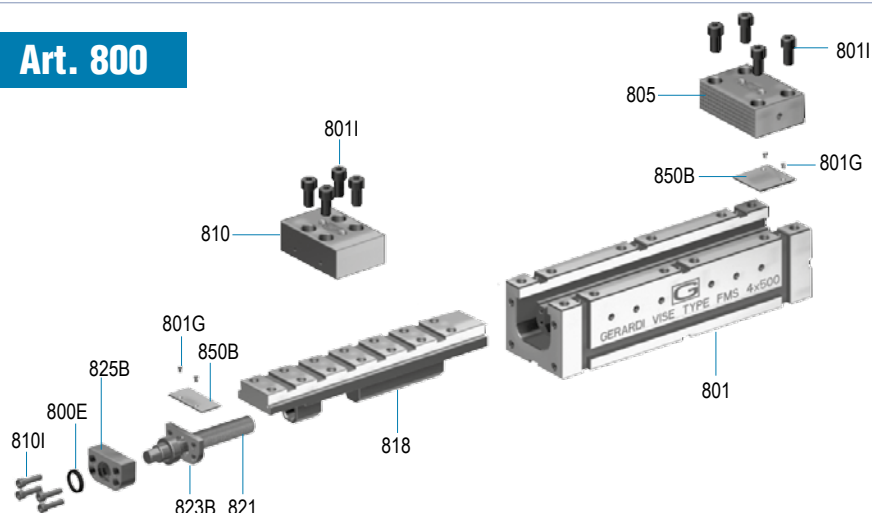
**Art. 800**

Art.	Pag.	Art.	Pag.
<b>800E</b>	5.61	-	-
<b>801</b>	5.46	-	-
<b>801G</b>	5.61	-	-
<b>801I</b>	5.61	-	-
<b>805</b>	5.54	-	-
<b>810</b>	5.56	-	-
<b>818</b>	5.50	-	-
<b>821</b>	5.52	-	-
<b>823B</b>	5.59	-	-
<b>825B</b>	5.59	-	-
<b>850B</b>	5.61	-	-

Tipo (grandezza) morsa / Vise type (size)		1		2		3			
kN		25 kN		25 kN		30 kN			
Apertura massima / Maximum opening		A	-	-	-	-	232	332	
<b>Art. 900</b>		B	-	-	-	-	40		
<b>NEW!</b>		C	-	-	-	-	100		
Morsa a Serraggio Meccanico con Limitatore di Forza solo per serraggi singoli		D	-	-	-	-	510	610	
		E	-	-	-	-	400	500	
Mechanical Clamping vise with Limiting Device only for single clamping		G	-	-	-	-	125		
		W	-	-	-	-	124		
kg		-	-	-	-	-	-	-	
Cod.		-	-	-	-	-	5.90.03400	5.90.03500	
€		<b>ATTUALMENTE NON DISPONIBILI - CURRENTLY NOT AVAILABLE</b>							

Questa morsa, pur essendo parte del programma FMS, non è predisposta per serraggi doppi o autocentranti

<b>Art. 900Y</b>		Cod.	-	-	5.90.0Y300
Modulo per serraggio idraulico Module for hydraulic clamping		€	<b>ATTUALMENTE NON DISPONIBILI - CURRENTLY NOT AVAILABLE</b>		

## 5 FUNZIONAMENTO LIMITATORE DI FORZA - HOW TO USE THE LIMITING DEVICE

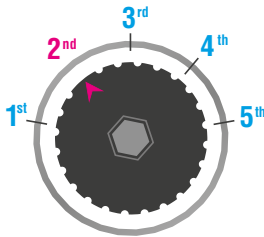

**1** Scegliere forza di serraggio tramite ghiera limitatore di forza.  
Presetting of the clamping force through the clamping limiter

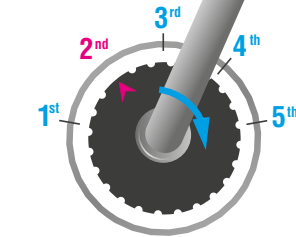

**2** Rapido avvicinamento ganascia mobile al pezzo da serrare  
Quick approach of the jaw to the workpiece

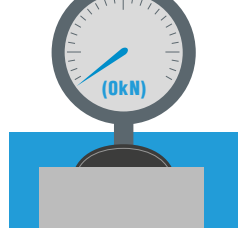

**3** Contatto ganascia-particolare e sblocco frizione limitatore di forza.  
First contact jaw-workpiece and clamping limiter friction release

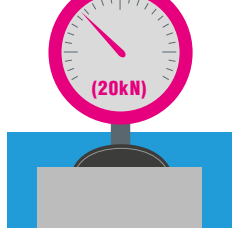

**4** Avvio meccanismo moltiplica forza. Fermarsi a fine corsa.  
Force multiplier device start. At the end-stroke stop clamping.

### Dotazione standard:

- 1 arresto laterale Art. 370
- 1 coppia di tasselli di posizionamento precisi Art. 297
- 1 chiave a pipa Art. 375

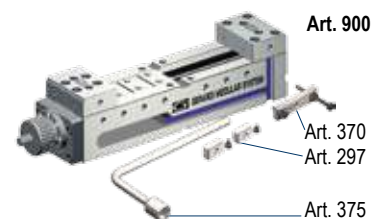

### Standard equipment:

- 1 workstop Art. 370
- 1 pair of precision positioning key-nuts Art. 297
- 1 box wrench Art. 375

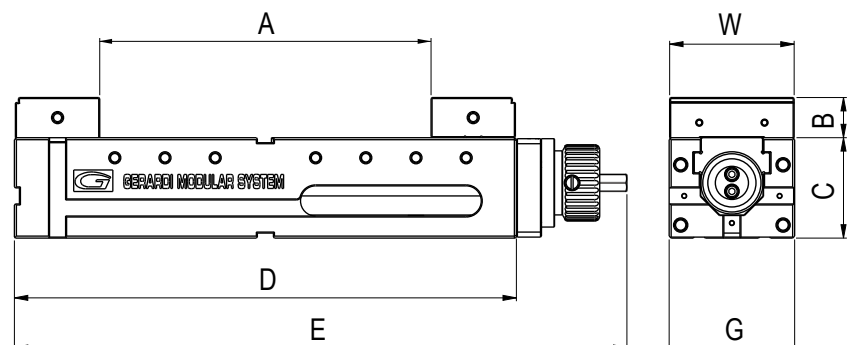

3 30 kN			4 30 kN				5 32 kN			6 32 kN		
432	532	632	304	404	505	605	384	484	584	-	-	-
	40			50				60				
	100			120				140				
710	810	910	610	710	810	910	710	810	910	-	-	-
600	700	800	500	600	700	800	600	700	800	-	-	-
	125			145				170				
	124			144				169				
5.90.03600	5.90.03700	5.90.03800	5.90.04500	5.90.04600	5.90.04700	5.90.04800	5.90.05600	5.90.05700	5.90.05800	-	-	-
										ATTUALMENTE NON DISPONIBILI CURRENTLY NOT AVAILABLE		

This type of vise even if it is part of the FMS series is not suitable for double or self-centering clamping

**Art. 900Y**

5.90.0Y300

5.90.0Y300

5.90.0Y300

 ATTUALMENTE NON DISPONIBILI  
 CURRENTLY NOT AVAILABLE

**DIAGRAMMI CON FORZE DI SERRAGGIO - DIAGRAMS WITH CLAMPING FORCE**
**MORSE FMS TIPO 3  
FMS VISES TYPE 3**

VITE: Ø 24 mm / Ø 30 mm PASSO: 2 mm  
 SCREW: Ø 24 mm / Ø 30 mm PITCH: 2 mm  
 Chiave dinamometrica / Torque wrench

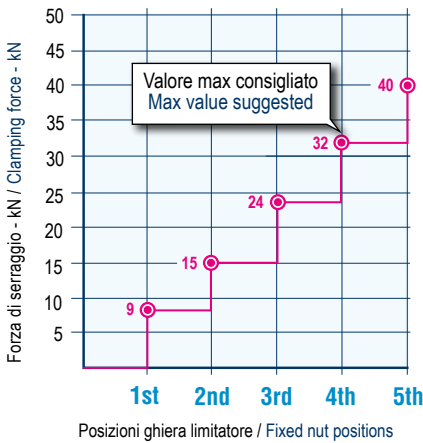
**MORSE FMS TIPO 4  
FMS VISES TYPE 4**

VITE: Ø 24 mm / Ø 30 mm PASSO: 2 mm  
 SCREW: Ø 24 mm / Ø 30 mm PITCH: 2 mm  
 Chiave dinamometrica / Torque wrench

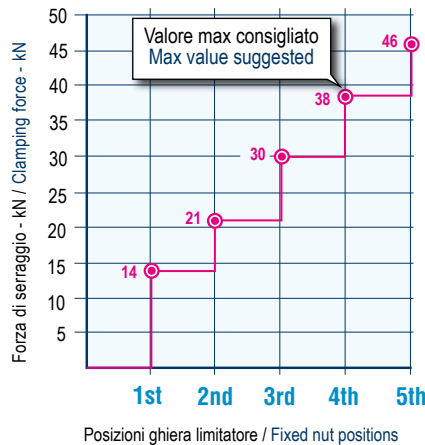
**MORSE FMS TIPO 5  
FMS VISES TYPE 5**

VITE: Ø 24 mm / Ø 30 mm PASSO: 2 mm  
 SCREW: Ø 24 mm / Ø 30 mm PITCH: 2 mm  
 Chiave dinamometrica / Torque wrench

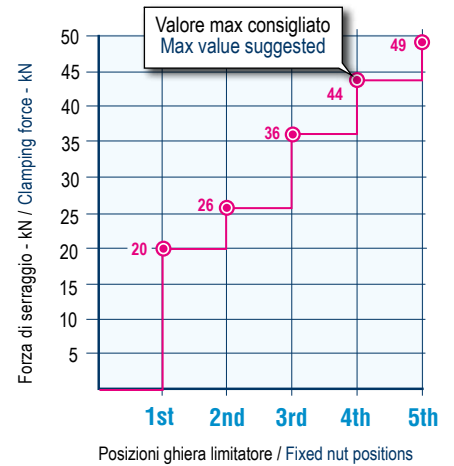
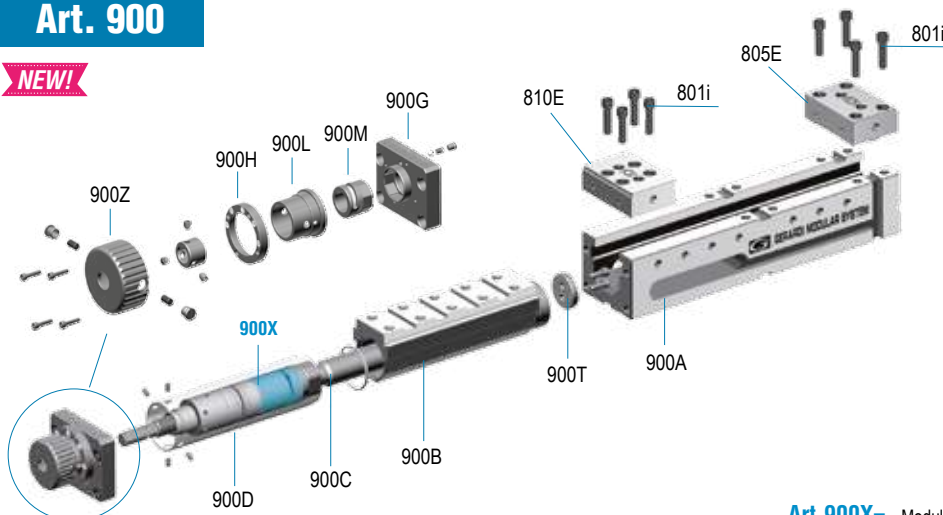

**Art. 900**
**NEW!**

Art.	Pag.
900Y	38
810E	57
805E	55

**Art. 900X=** Modulo per serraggio meccanico - Module for mechanical clamping

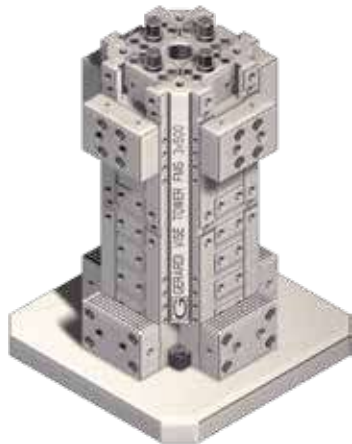

Tipo (grandezza) morsa / Vise type (size)	kN	1 25 kN		2 25 kN			3 30 kN		
Apertura massima / Max. opening	A	85	185	170	270	370	470	230	330
<b>Art. 800C</b> SPECIFICA SOLO PER SERRAGGI SINGOLI SPECIFIC FOR SINGLE CLAMPING ONLY	A1	115		130			170		
	B	25		30			40		
	D	200	300	300	400	500	600	400	500
	E	232	332	320	420	520	620	425	525
	G1	120		175			210		
	L	300		350			400		
	M	33		33			38		
	W	74		94			124		
	kg	30	45	53	70	88	106	90	112

 Cubo-morsa FMS con ganasce  
 piane per il serraggio di 4 pezzi

Cod.	5.80.0C120	5.80.0C130	5.80.0C230	5.80.0C240	5.80.0C250	5.80.0C260	5.80.0C340	5.80.0C350
------	------------	------------	------------	------------	------------	------------	------------	------------

 FMS vise tower with straight  
 jaws for 4 clamping stations

Questa morsa, pur essendo parte del programma FMS, non è predisposta per serraggi doppi o autocentranti

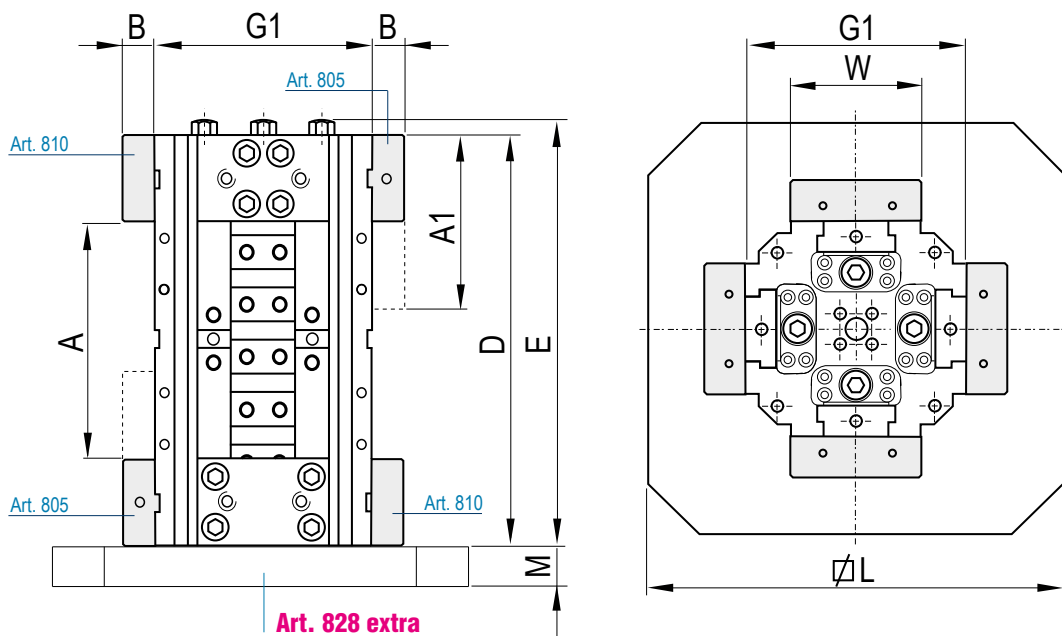
**GANASCE REVERSIBILI**  
**REVERSIBLE JAWS**

**Dotazione standard per Art. 800C**

- 1 chiave a pipa Art. 375
- 4 arresti laterali Art. 370
- 2 coppie di tasselli di posizionamento precisi Art. 297
- 1 golfare di sollevamento Art. 848
- Imballo in cassa di legno

**Standard equipment for Art. 800C**

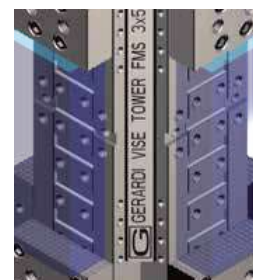
- 1 box wrench Art. 375
- 4 workstops Art. 370
- 2 pair of precision positioning key-nuts Art. 297
- 1 lifting hook Art. 848
- Wooden box packaging



3 30 kN			4 30 kN				5 32 kN			6 32 kN		
430	530	630	300	400	500	600	380	480	580	480	580	680
170			509				630			810		
40			50				60			60		
600	700	800	500	600	700	800	600	700	800	800	900	1000
625	725	825	525	625	725	825	625	725	825	825	925	1025
210			245				280			290		
400			450				500			550		
38			38				38			38		
124			144				169			189		
135	157	180	180	210	252	288	260	303	340	500	562	625

5.80.0C360 5.80.0C370 5.80.0C380 5.80.0C450 5.80.0C460 5.80.0C470 5.80.0C480 5.80.0C560 5.80.0C570 5.80.0C580 5.80.0C680 5.80.0C690 5.80.0C610

This type of vise even if it is part of the FMS series is not suitable for double or self-centering clamping

**GANASCE REVERSIBILI  
REVERSIBLE JAWS**

**Art. 800C**

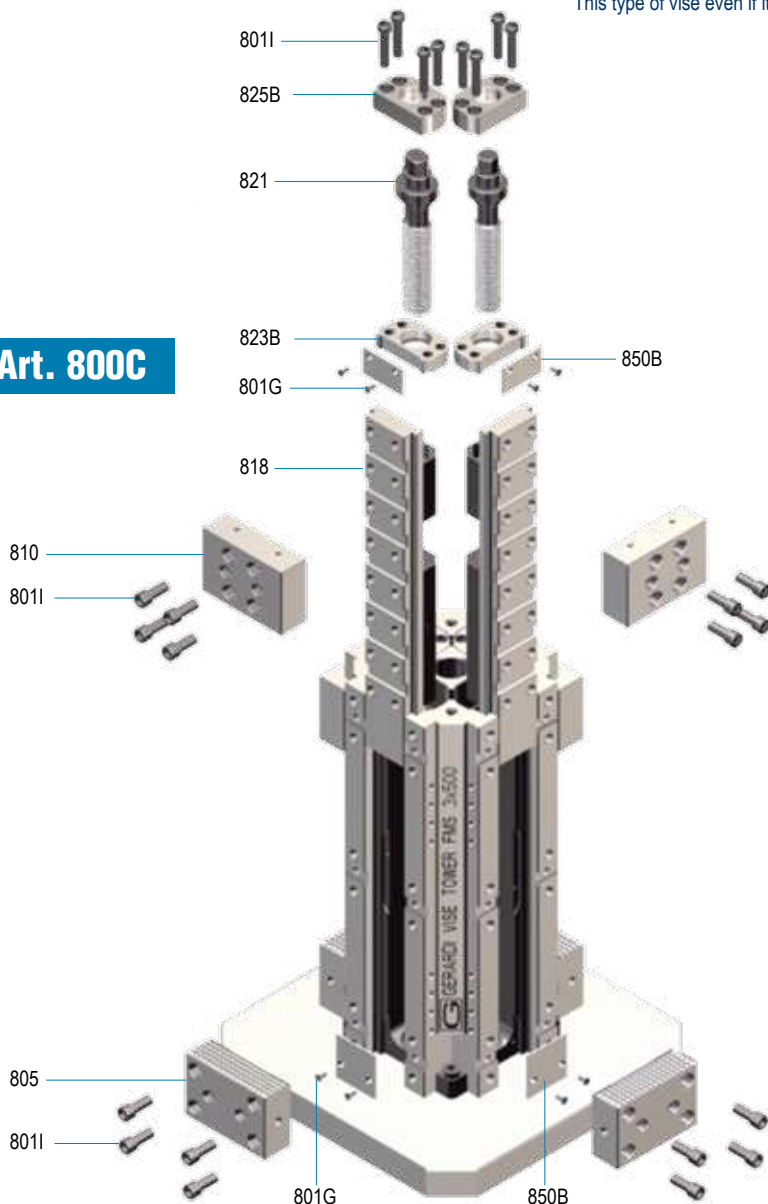

Esplodo di cubo-morsa FMS con ganasce piane per il serraggio di 4 pezzi  
 Explode of FMS vise tower with straight jaws for 4 clamping stations

Art.	Pag.	Art.	Pag.
<b>801G</b>	5.61	-	-
<b>8011</b>	5.61	-	-
<b>810</b>	5.56	-	-
<b>818</b>	5.50	-	-
<b>821</b>	5.52	-	-
<b>823B</b>	5.59	-	-
<b>825B</b>	5.59	-	-
<b>850B</b>	5.61	-	-
-	-	-	-
-	-	-	-
-	-	-	-

Tipo (grandezza) morsa / Vise type (size)		1 25 kN		2 25 kN				3 30 kN											
Apertura massima / Max. opening		kN		2 x 16		2 x 66		2 x 54		2 x 104		2 x 154		2 x 204		2 x 74		2 x 124	
<b>Art. 860C</b>																			
Cubo-morsa FMS doppio per il serraggio di 8 pezzi																			
Double FMS vise tower for 8 clamping stations																			
		B		25		30		40											
		D		200		300		300		400		500		600		400		500	
		E		232		332		320		420		520		620		425		525	
		G1		120		175		210											
		L		300		350		400											
		M		33		33		38											
		W		74		94		124											
		kg		30		45		53		70		88		106		90		112	
		Cod.		5.860.0C120		5.86.0C130		5.86.0C230		5.86.0C240		5.86.0C250		5.86.0C260		5.86.0C340		5.86.0C350	

**Art. 855C**

 Modulo base cubo morsa FMS doppia (senza ganasce)  
 FMS Double vise tower base (without jaws)

Cod.	5.85.5C120	5.85.5C130	5.85.5C230	5.85.5C240	5.85.5C250	5.85.5C260	5.85.5C340	5.85.5C350
------	------------	------------	------------	------------	------------	------------	------------	------------

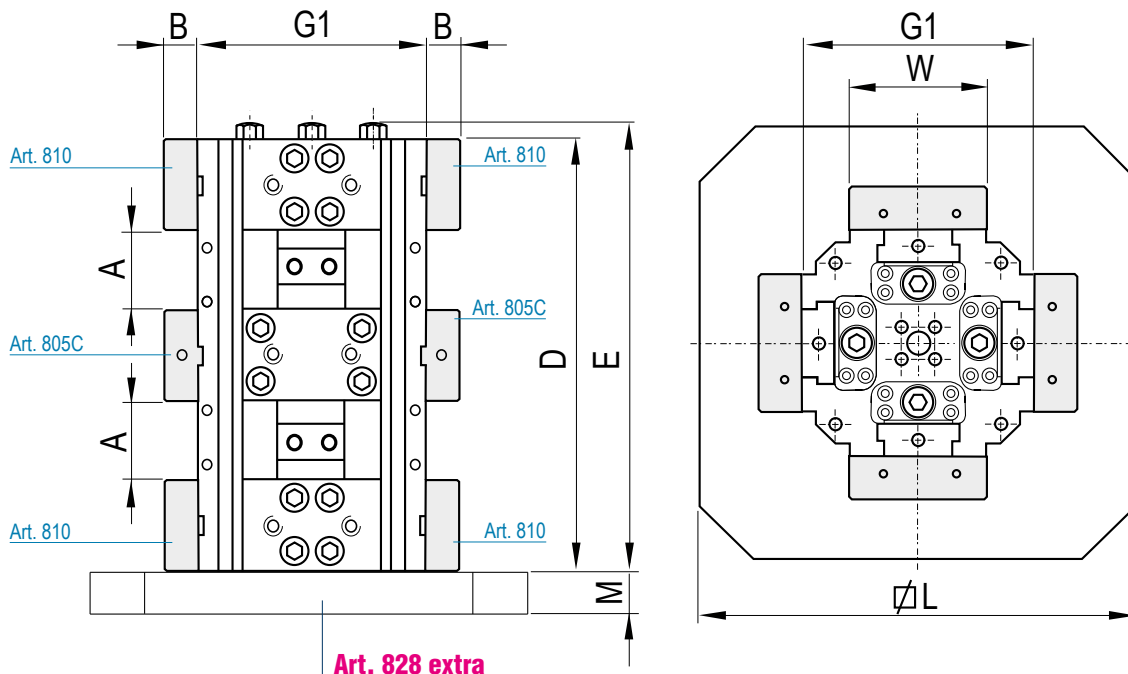
**GANASCE REVERSIBILI  
REVERSIBLE JAWS**

**Dotazione standard per Art. 860C**

- 1 chiave a pipa Art. 375
- 4 arresti laterali Art. 370
- 2 coppie di tasselli di posizionamento precisi Art. 297
- 1 golphare di sollevamento Art. 848
- Imballo in cassa di legno
- Meccanismo 3<sup>a</sup> mano

**Standard equipment for Art. 860C**

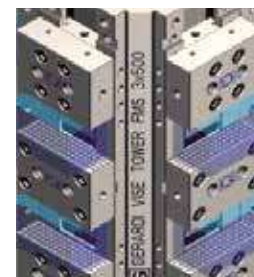
- 1 box wrench Art. 375
- 4 workstops Art. 370
- 2 pair of precision positioning key-nuts Art. 297
- 1 lifting hook Art. 848
- Wooden box packaging
- Third hand device



3 30 kN			4 30 kN				5 32 kN			6 32 kN		
2 x 174	2 x 224	2 x 274	2 x 103	2 x 153	2 x 203	2 x 253	2 x 138	2 x 188	2 x 238	2 x 238	2 x 288	2 x 338
40			50				60			60		
600	700	800	500	600	700	800	600	700	800	800	900	1000
625	725	825	525	625	725	825	625	725	825	825	925	1025
210			245				280			290		
400			450				500			550		
38			38				38			38		
124			144				169			189		
135	157	180	180	210	252	288	260	303	340	500	562	625
5.86.0C360	5.86.0C370	5.86.0C380	5.86.0C450	5.86.0C460	5.86.0C470	5.86.0C480	5.86.0C560	5.86.0C570	5.86.0C580	5.86.0C680	5.86.0C690	5.86.0C610
5.85.5C360	5.85.5C370	5.85.5C380	5.85.5C450	5.85.5C460	5.85.5C470	5.85.5C480	5.85.5C560	5.85.5C570	5.85.5C580	5.85.5C680	5.85.5C690	5.85.5C610

**GANASCE REVERSIBILI**  
**REVERSIBLE JAWS**

### Art. 860C

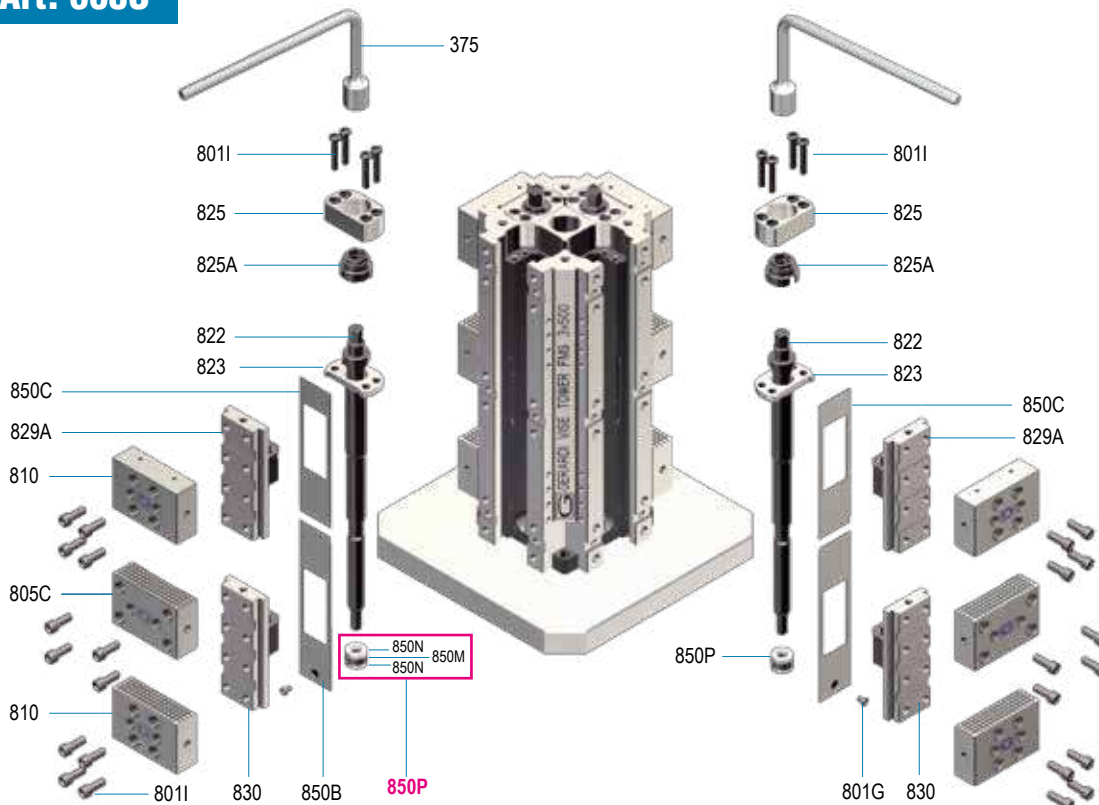

Art.	Pag.
<b>375</b>	4.31
<b>801G</b>	5.61
<b>8011</b>	5.61
<b>805C</b>	5.54
<b>810</b>	5.56
<b>822</b>	5.52
<b>823</b>	5.59
<b>825</b>	5.59
<b>825A</b>	5.61
<b>829A</b>	5.50
<b>830</b>	5.50
<b>850B</b>	5.61
<b>850C</b>	5.61
<b>850P</b>	5.61
-	-
-	-
-	-

Tipo (grandezza) morsa / Vise type (size)	kN	1 25 kN		2 25 kN				3 30 kN	
Apertura massima Max. opening	A	2 x 60	2 x 110	2 x 118	2 x 168	2 x 218	2 x 268	2 x 162	2 x 212

**Art. 863C**

Cubo morsa  
FMS doppio con  
ganasse a gradino  
per il serraggio  
di 8 pezzi



Double FMS vise  
tower with step-type  
jaws for 8 clamping  
stations

Cod.	5.86.3C120	5.86.3C130	5.86.3C230	5.86.3C240	5.86.3C250	5.86.3C260	5.86.3C340	5.86.3C350
------	------------	------------	------------	------------	------------	------------	------------	------------

Ø Apertura Minima / Massima Ø Minimum - Max Opening	A	10 / 25	10 / 50				25 / 100	
--	---	---------	---------	--	--	--	----------	--

**Art. 870C**

Cubo morsa  
FMS autocentrante  
con ganasse  
prismatiche



Self-centering FMS vise  
tower with prismatic  
jaws

Cod.	5.870.0C120	5.870.0C130	5.870.0C230	5.870.0C240	5.870.0C250	5.870.0C260	5.870.0C340	5.870.0C350
D	200	300	300	400	500	600	400	500
E	232	332	320	420	520	620	425	525
G1	120			175			210	
L	300			350			400	
M	33			33			38	
W	74			94			124	
W1	60			75			100	
kg	42	63	68	90	113	130	118	147

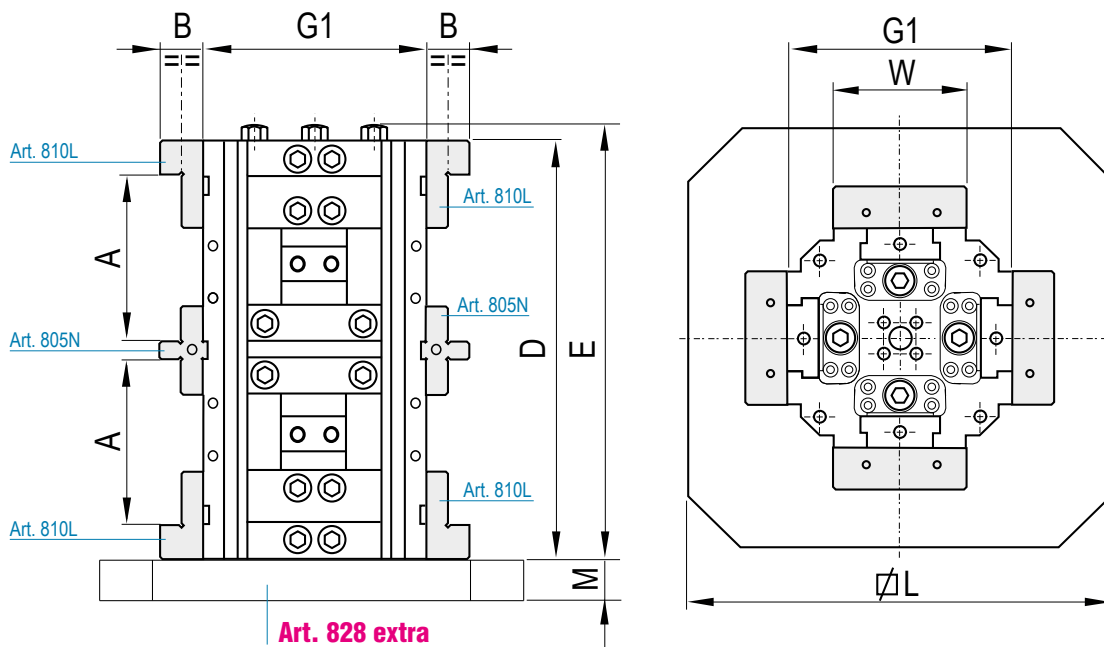
**Dotazione standard per  
Art. 863C e Art. 870C:**

- 1 chiave a pipa Art. 375
- 4 arresti laterali Art. 370
- 2 coppie di tasselli di posizionamento precisi Art. 297
- 1 goliere di sollevamento Art. 848
- Imballo in cassetta di legno
- Meccanismo 3<sup>a</sup> mano

**Standard equipment for  
Art. 863C and Art. 870C:**

- 1 box wrench Art. 375
- 4 workstops Art. 370
- 2 pair of precision positioning key-nuts Art. 297
- 1 lifting hook Art. 848
- Packaging wooden box
- Third hand device





3 30 kN			4 30 kN				5 32 kN			6 32 kN		
2 x 262	2 x 312	2 x 362	2 x 204	2 x 254	2 x 304	2 x 354	2 x 254	2 x 304	2 x 354	2 x 354	2 x 404	2 x 454
5.86.3C360	5.86.3C370	5.86.3C380	5.86.3C450	5.86.3C460	5.86.3C470	5.86.3C480	5.86.3C560	5.86.3C570	5.86.3C580	5.86.3C680	5.86.3C690	5.86.3C610

25 / 100			30 / 150				35 / 200			40 / 300		
5.87.0C360	5.87.0C370	5.87.0C380	5.87.0C450	5.87.0C460	5.87.0C470	5.87.0C480	5.87.0C560	5.87.0C570	5.87.0C580	5.87.0C680	5.87.0C690	5.87.0C610
600	700	800	500	600	700	800	600	700	800	800	900	1000
625	725	825	525	625	725	825	625	725	825	825	925	1025
	210				245				280		290	
	400				450				500		550	
	38				38				38		38	
	124				144				169		189	
	100				132				140		160	
177	206	236	242	290	339	388	328	383	437	656	738	820

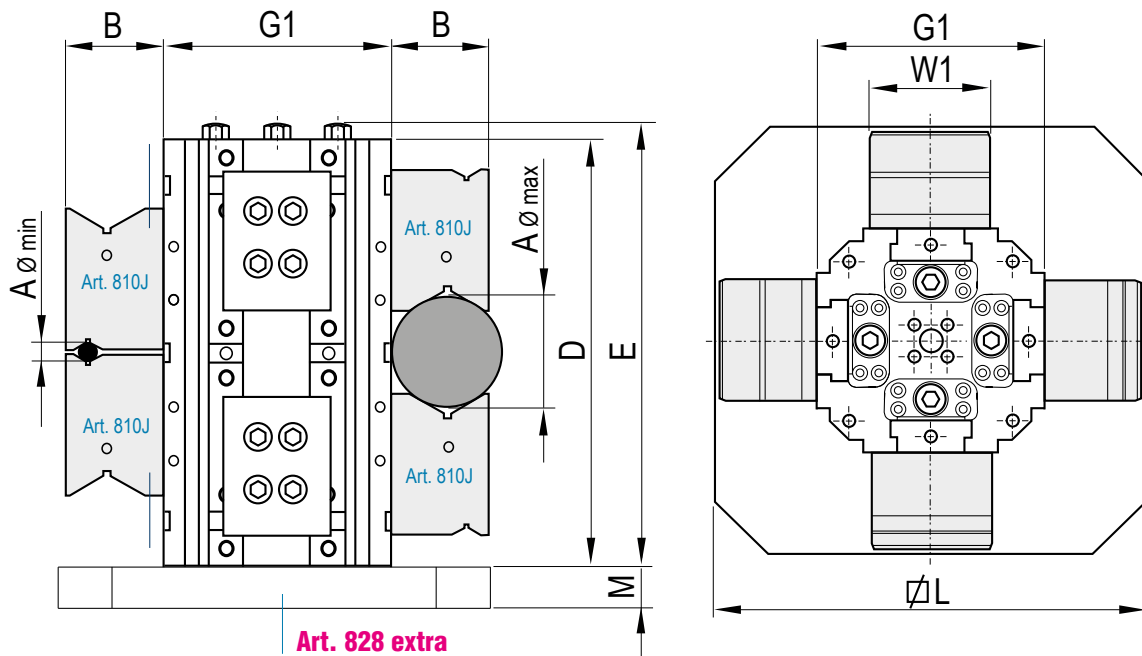
**Dotazione standard per Art. 863C e Art. 870C:**

- 1 chiave a pipa Art. 375
- 4 arresti laterali Art. 370
- 2 coppie di tasselli di posizionamento precisi Art. 297
- 1 golfare di sollevamento Art. 848
- Imballo in cassetta di legno
- Meccanismo 3<sup>a</sup> mano

**Standard equipment for Art. 863C and Art. 870C:**

- 1 box wrench Art. 375
- 4 workstops Art. 370
- 2 pair of precision positioning key-nuts Art. 297
- 1 lifting hook Art. 848
- Packaging wooden box
- Third hand device



Tipo (grandezza) morsa / Vise type (size)

**1**
**2**
**Art. 801**

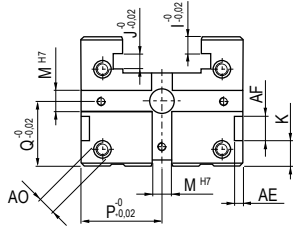
 Base morsa FMS. Disegni e tabella dimensionale  
 FMS vise base body. Drawing and table dimension

Vista da C / Side C

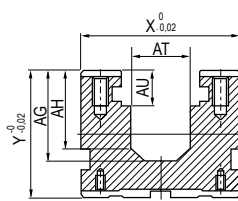

Sezione AA / AA section

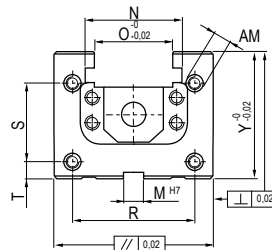

Vista da B / Side B

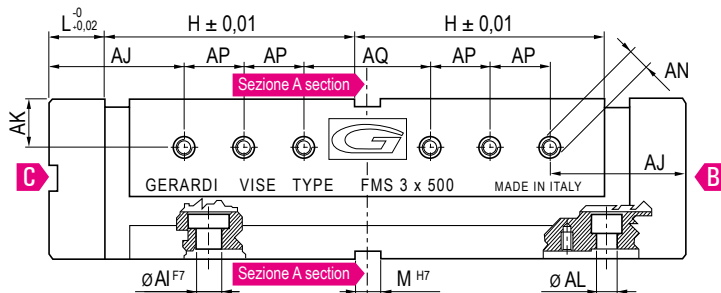

Vista dal basso / Show bottom

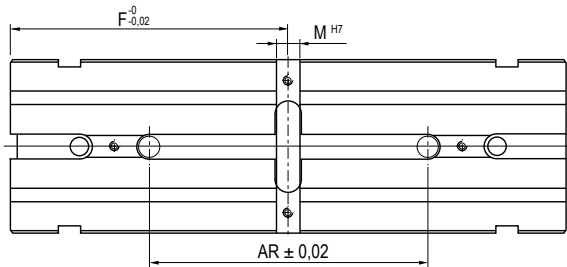

Vista dall'alto / Show top

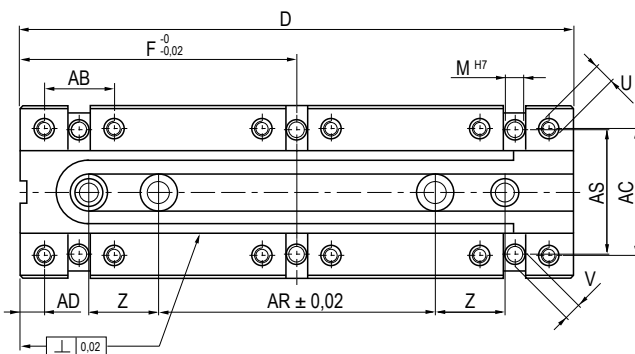

kg	4,7	7,3	12,8	19
----	-----	-----	------	----

Cod.	5.80.11200	5.80.11300	5.80.12300	5.80.12400
------	------------	------------	------------	------------

D	200	300	300	400
F	100	150	150	200
H	71	121	117	167
I	10		13	
J	10		12	
K	15		20	
L	21		25	
M	16		16	
N	45		53	
O	35		41	
P	37,5		47,5	
Q	35		45	
R	52		70	
S	30		48	
T	20		22	
U	M8		M10	
V	M8		M10	
Z	50		50	
X	75		95	
Y	70		90	
AB	32		40	
AC	56		70	
AD	13		13	
AE	4		6	
AF	16		16	
AG	49		62	
AH	41		53	
AI	Ø 16 X 2		Ø 16 X 2	
AJ	55		65	
AK	20		27	
AL	Ø 11		Ø 13	
AM	n°0 M10	n°2 M10	n°2 M10	n°2 M10
AN	n°8 M10	n°12 M10	n°12 M10	n°16 M10
AO	M10		M10	
AP	20	25	50	
AQ	50	70	70	
AR	100	200	200	
AS	56		68	
AT	28		34	
AU	23		28	

**PIASTRE D'INTERFACCIA Art.62 per morse FMS**  
**CONNECTING PLATES Art.62 for FMS vises**
**NEW!**

Tipo (grandezza) morsa / Vise type (size)

**1**
**2**
**Art. 62**
**FMS**

 Piastra di interfaccia  
 Zero Point per morse FMS

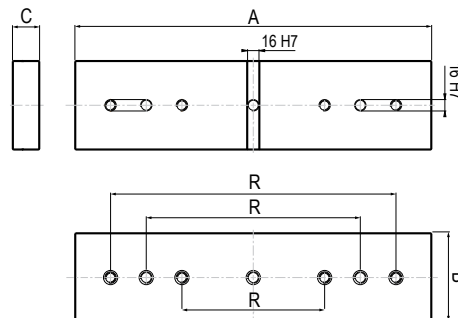
 Zero Point connecting  
 plate for FMS vises

A	232	332	300	400
B	75		95	
C	38		38	
R	200 / 300		200 / 300 / 400	
kg	5	7	11	13,4

Cod.	5.62.12000	5.62.13000	5.62.23000	5.62.24000
------	------------	------------	------------	------------

2		3					4				5			6		
23	27	26	31	39	46	52	47	56	65	75	71	82	94	140	156	174
5.80.12500	5.80.12600	5.80.13400	5.80.13500	5.80.13600	5.80.13700	5.80.13800	5.80.14500	5.80.14600	5.80.14700	5.80.14800	5.80.15600	5.80.15700	5.80.15800	5.80.16800	5.80.16900	5.80.16100

500	600	400	500	600	700	800	500	600	700	800	600	700	800	800	900	1000	
250	300	200	250	300	350	400	250	300	350	400	300	350	400	400	450	500	
217	267	157	207	257	307	357	200	250	300	350	245	295	345	345	395	445	
13				13					20			20			20		
12				12					18			18			18		
20				20					20			26			26		
25				35					42			47			47		
16				16					16			16			16		
53				76					86			96			110		
41				61					71			82			94		
47,5				62,5					72,5			85			95		
45				50					60			70			80		
70				92					108			126			144		
48				62					72			92			100		
22				13					16			18			20		
M10				M12					M16			M16			M20		
M10				M12					M12			M12			M12		
50				50					50			50			50		
95				125					145			170			190		
90				100					120			140			160		
40				50					60			68			68		
70				92					108			126			144		
13				18					20			21			20		
6				6					10			10			10		
16				16					16			16			16		
62				72					80			95			105		
53				62					70			82			95		
Ø 16 x 2				Ø 16 x 2					Ø 16 x 2			Ø 16 x 2			Ø 16 x 2		
65				100					100			100			125		
27				32					40			48			58		
Ø 13				Ø 13					Ø 13			Ø 17			Ø 17		
n° 4	n° 6	n° 2	n° 4	n° 6	n° 8	n° 10	n° 4	n° 6	n° 8	n° 10	n° 6	n° 8	n° 10	n° 10	n° 12	n° 14	
M10				M12					M12			M16			M20		
M10				M10M					M10			M10					
n° 20	n° 24	n° 8	n° 12	n° 16	n° 20	n° 24	n° 12	n° 16	n° 20	n° 24	n° 16	n° 20	n° 24	n° 24	n° 28	n° 32	
M10				M12					M16			M16			M20		
50				50					50			50			50		
70				100					100			100			125		
200				200					200			400	400	600	400	400	400
68				92					106			126			144		
34				44					44			52			49		
28				28					41			41			41		

**PIASTRE D'INTERFACCIA Art.62 per morse FMS**  
**CONNECTING PLATES Art.62 for FMS vises**



2		3					4				5			6		
500	600	400	500	600	700	800	500	600	700	800	600	700	800	800	900	1000
95				125					145			170			190	
38				38					38			38			38	
200 / 300 / 400				200 / 300 / 400					200 / 300 / 400			200 / 300 / 400			200 / 300 / 400	
16,1	18,9	13,9	17,8	21,5	25,1	28,5	20,8	25	29,3	33,5	29	34	39	44	49	55
5.62.25000	5.62.26000	5.62.34000	5.62.35000	5.62.36000	5.62.37000	5.62.38000	5.62.45000	5.62.46000	5.62.47000	5.62.48000	5.62.56000	5.62.57000	5.62.58000	5.62.68000	5.62.69000	5.62.61000

Tipo (grandezza) morsa / Vise type (size)

**1**
**2**
**Art. 804**

 Corpo base cubo FMS. Disegni e tabella dimensionale  
 FMS cube base body. Drawing and table dimension

Cod. 5.80.41200 5.80.41300 5.80.42300 5.80.42400

	200	300	300	400
D	200	300	300	400
F	140		175	
H	71	121	117	167
I	10		13	
J	10		12	
K	13		13	
L	21		25	
M	16		16	
N	45		53	
O	35		41	
P	M10		M12	
Q	11		13	
R	-		100	
S	-		40	
T	-		120	
U	M8		M10	
V	M8		M10	
Z	M10		M10	
X	75		95	
Y	70		85	
AB	32		40	
AC	56		70	
AD	56		68	
AE	50	70	70	
AF	10	25	50	
AG	49		62	
AH	41		53	

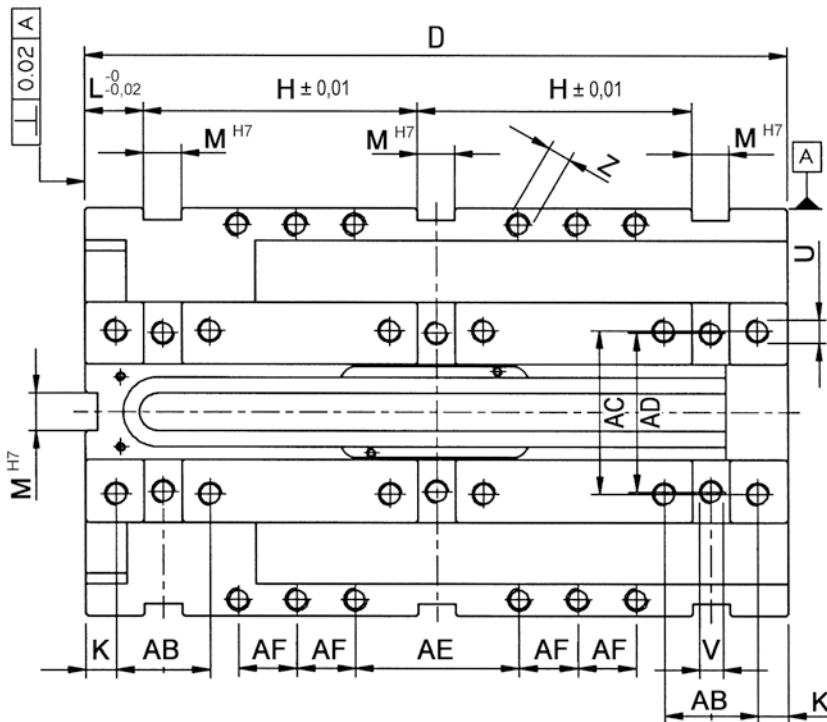

2		3					4				5			6		
5.80.42500	5.80.42600	5.80.43400	5.80.43500	5.80.43600	5.80.43700	5.80.43800	5.80.44500	5.80.44600	5.80.44700	5.80.44800	5.80.45600	5.80.45700	5.80.45800	5.80.46800	5.80.46900	5.80.46100
500	600	400	500	600	700	800	500	600	700	800	600	700	800	800	900	1000
175				210					245			280			290	
217	267	157	207	257	307	357	200	250	300	350	235	285	335	345	395	445
13				13					20			20			20	
12				12					18			18			18	
13				18					20			21			21	
25				35					42			47			47	
16				16					16			16			16	
53				76					86			96			110	
41				61					71			82			94	
M12				M12					M16			M16			M20	
13				13					13			17			17	
100				120					150			150			150	
40				40					40			50			50	
120				150					170			210			210	
M10				M12					M16			M16			M20	
M10				M12					M12			M12			M12	
M10				M10					M10			M10			M10	
95				125					145			170			190	
85				110					125			140			130	
40				50					60			68			68	
70				92					108			126			144	
68				92					106			126			144	
70				100					100			100			125	
50				50					50			50			50	
62				62					80			95			105	
53				72					70			82			95	

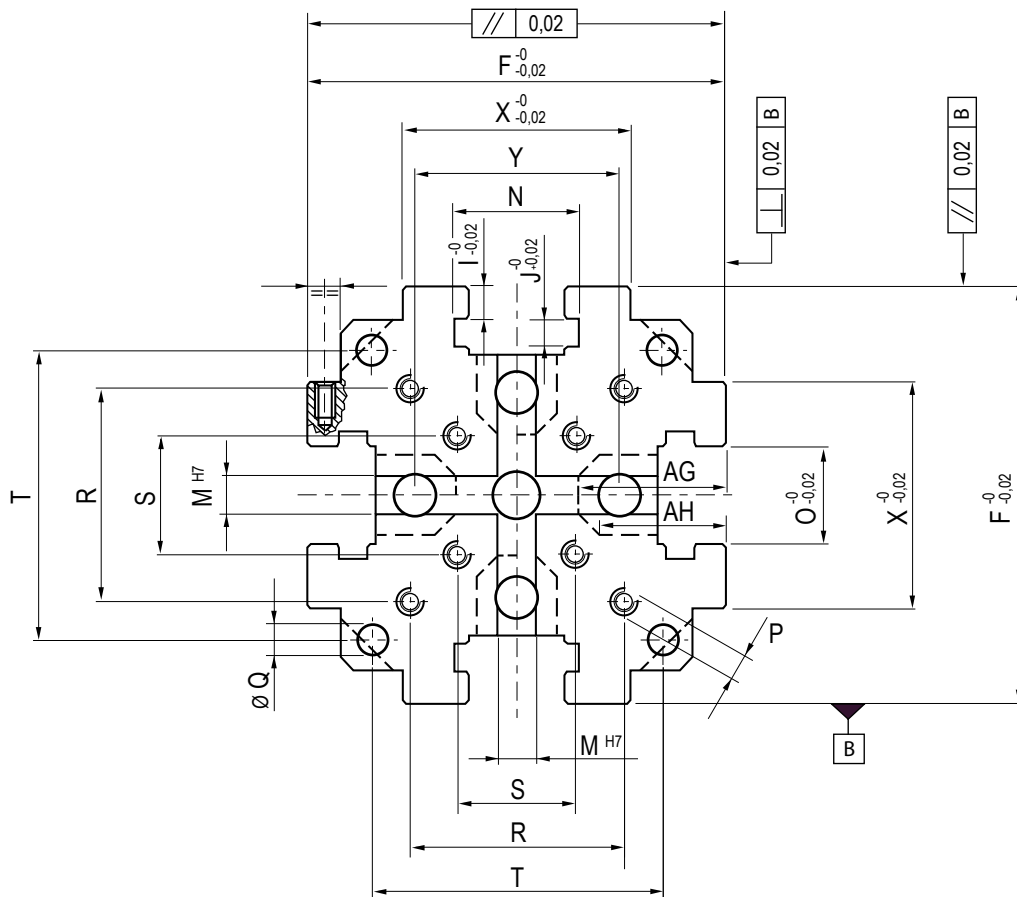



Tipo (grandezza) morsa / Vise type (size)

**1**
**2**

Larghezza base / Base length

200

300

300

400

Cod. 5.81.81200 5.81.81300 5.81.82300 5.81.82400

**Art. 818**

Slitta integrale lunga / Solid long slide

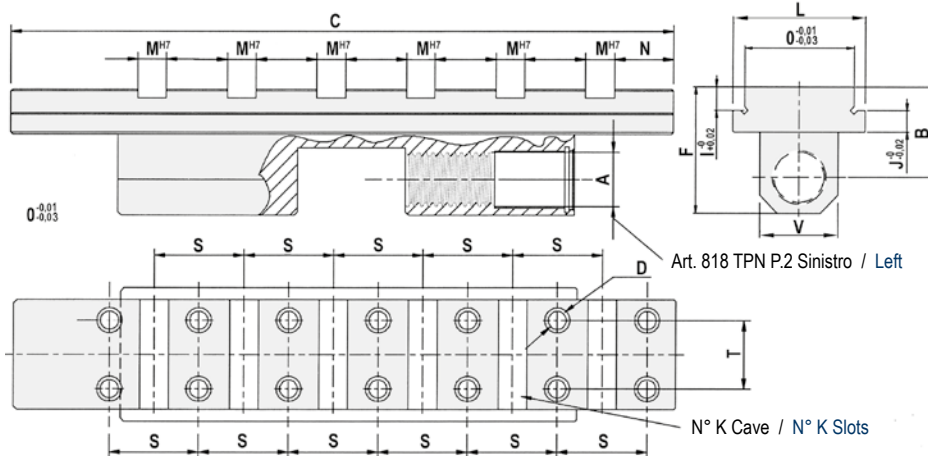

Art. 818 TPN P.2 Sinistro / Left

N° K Cave / N° K Slots

A	18		24	
A1	18		18	
A2	24		24	
B	35		45	
C	170	264	256	356
D	M8		M10	
E	72	116	102	142
F	48,5		61,5	
G	15	18	23	
H	2	3	2	3
I	10		13	
J	10		12	
K	-	-	5	7
L	44		51	
M	16		16	
N	20		23	
O	35		41	
S	26	32	40	
T	20		25	
V	27		33	
W	10	16	24	

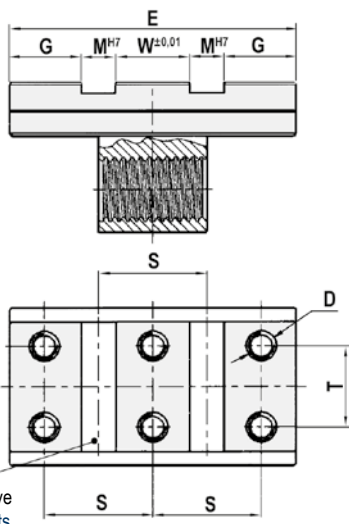
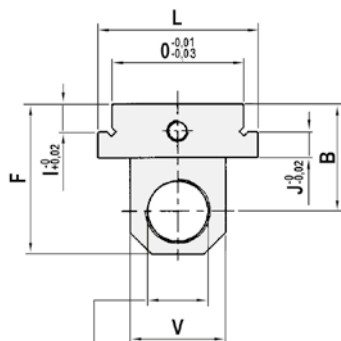
 N° H Cave  
 N° H Slots

 A1 Art. 829A TPN P.2 Destro / Right  
 A2 Art. 830 TPN P.2 Sinistro / Left

**Art. 829A**

Slitta con filetto sinistro / Slide Right Hand



Cod. 5.82.9A120 5.82.9A130 5.82.9A230 5.82.9A240

**Art. 830**

Slitta con filetto destro / Slide Left Hand

Cod. 5.83.01200 5.83.01300 5.83.02300 5.83.02400

2		3					4				5			6		
500	600	400	500	600	700	800	500	600	700	800	600	700	800	800	900	1000
5.81.82500	5.81.82600	5.81.83400	5.81.83500	5.81.83600	5.81.83700	5.81.83800	5.81.84500	5.81.84600	5.81.84700	5.81.84800	5.81.85600	5.81.85700	5.81.85800	5.81.86800	5.81.86900	5.81.86100

24	30					30				36			36			
18	24					24				30			30			
24	30					30				36			36			
45	50					60				70			80			
456	556	346	446	546	646	746	435	535	635	735	525	625	725	725	825	925
M10		M12					M16				M16			M20		
182	222	132	182	232	282	332	156	216	276	336	174	242	310	242	310	378
61,5		71					80				95			106		
23		33					40				45			45		
4	5	2	3	4	5	6	2	3	4	5	2	3	4	3	4	5
13		13					20				20			20		
12		12					18				18			18		
9		5					5				6			9		
51		74					84				95			108		
16		16					16				16			16		
23		33					40				45			45		
41		61					71				82			94		
40		50					60				68			68		
25		38					44				44			54		
33		43					43				51			48		
24		34					44				52			52		

5.82.9A250 5.82.9A260 5.82.9A340 5.82.9A350 5.82.9A360 5.82.9A370 5.82.9A380 5.82.9A450 5.82.9A460 5.82.9A470 5.82.9A480 5.82.9A560 5.82.9A570 5.82.9A580 5.82.9A680 5.82.9A690 5.82.9A610

5.83.02500 5.83.02600 5.83.03400 5.83.03500 5.83.03600 5.83.03700 5.83.03800 5.83.04500 5.83.04600 5.83.04700 5.83.04800 5.83.05600 5.83.05700 5.83.05800 5.83.06800 5.83.06900 5.83.06100

Tipo (grandezza) morsa / Vise type (size)

**1**
**2**

Larghezza base / Base length

200

300

300

400

Cod. 5.82.11300

5.82.12600

**Art. 821**

Vite di bloccaggio con filetto sinistro / Main screw left thread

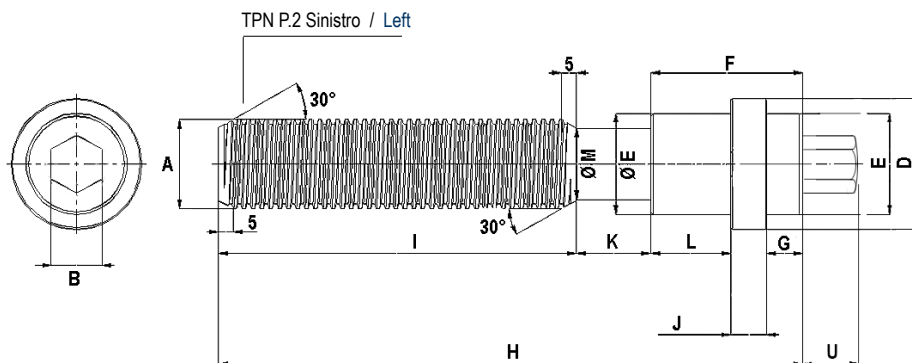

A	18	24		
A1	18	18		
A2	20	24		
B	16	16		
D	35	35		
E	20	25		
F	82	33		
G	13	12		
H	152	135		
I	65	90		
J	14	12		
K	5	12		
L	55	9		
M	14	19		
N	242	333	308	399
O	12	17	25	32
P	65	84	84	98
Q	32	66	66	106
R	68	85	75	94
S	44	6	38	49
T	32	32		
U	21	15		
AA	10	10		
AB	10	10		

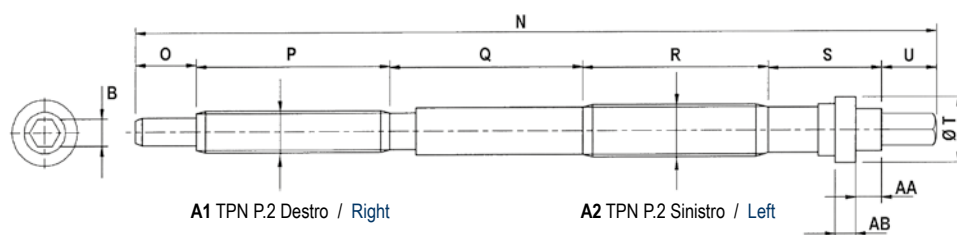
**Art. 822**

 Vite di bloccaggio con filetto destro e sinistro  
 Main screw right and left thread

 Viti con esagono maschio o femmina a seconda delle dimensioni  
 Screw available with external or internal hexagon

Cod. 5.82.11200 5.82.11300 5.82.12300 5.82.12400

2		3					4				5			6		
500	600	400	500	600	700	800	500	600	700	800	600	700	800	800	900	1000
5.82.12600		5.82.14800					5.82.14800				5.82.16100			5.82.16100		

24		30					30				36			36		
18		24					24				30			30		
24		30					30				36			36		
16		19					19				19			19		
35		45					45				48			48		
25		30					30				30			30		
33		42					42				115			115		
12		16					16				15			15		
135		136					186				225			225		
90		118					118				135			135		
12		15					15				20			20		
12		26					26				55			55		
9		11					11				80			80		
19		24					24				30			30		
500	600	414	499	599	699	822	499	599	699	797	610	700	790	790	881	961
52	52	25	35	54	87	121	35	54	87	121	47	71	101	101	81	100
116	151	123	123	140	124	118	123	140	124	118	176	158	140	140	205	187
134	164	82	132	160	226	282	132	160	226	282	124	192	256	256	245	308
116	136	118	118	140	124	118	118	140	124	118	176	158	140	140	205	187
62	77	41	66	80	113	136	66	80	113	136	62	96	128	128	120	154
32		38					38				45			45		
20		25					25				25			25		
10		15					15				22			22		
10		12					12				15			15		

5.82.12500 5.82.12600 5.82.13400 5.82.13500 5.82.13600 5.82.13700 5.82.13800 5.82.14500 5.82.14600 5.82.14700 5.82.14800 5.82.15600 5.82.15700 5.82.15800 5.82.16800 5.82.16900 5.82.16100

--	--	--	--	--	--	--	--	--	--	--	--	--	--	--	--	--

# GANASCE FISSE PER MORSE FMS

## FIXED JAWS FOR FMS VISES

Tipo (grandezza) / Type (size)	1	2	3	4	5	6
<b>Art. 805</b> Ganasia fissa zigrinata da un lato Fixed jaw one side serrated 	Cod. 5.80.51000	5.80.52000	5.80.53000	5.80.54000	5.80.55000	5.80.56000
<b>Art. 805A</b> Ganasia fissa liscia Smooth fixed jaw 	Cod. 5.80.5A100	5.80.5A200	5.80.5A300	5.80.5A400	5.80.5A500	5.80.5A600
<b>Art. 805B</b> Ganasia fissa dolce Soft fixed jaw 	Cod. 5.80.5B100	5.80.5B200	5.80.5B300	5.80.5B400	5.80.5B500	5.80.5B600
<b>Art. 805C</b> Ganasia fissa zigrinata da ambo i lati Fixed jaw serrated on both sides 	Cod. 5.80.5C100	5.80.5C200	5.80.5C300	5.80.5C400	5.80.5C500	5.80.5C600
<b>Art. 870A</b> <span style="color: red; font-weight: bold;">NEW!</span> Ganasia fissa intermedia alta Fixed Intermediate high jaw 	Cod. 5.87.01000	5.87.02000	5.87.03000	5.87.04000	5.87.05000	5.87.06000

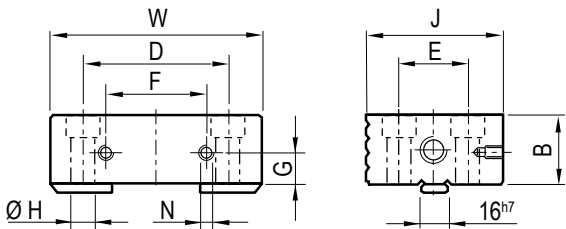
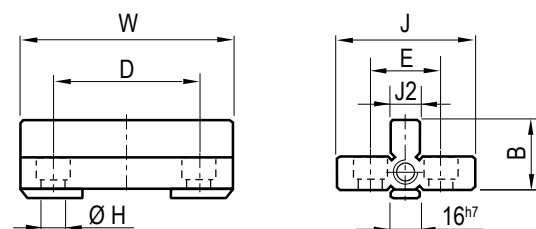
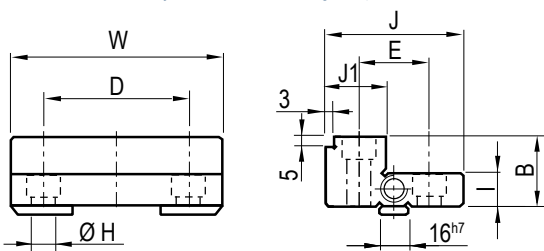
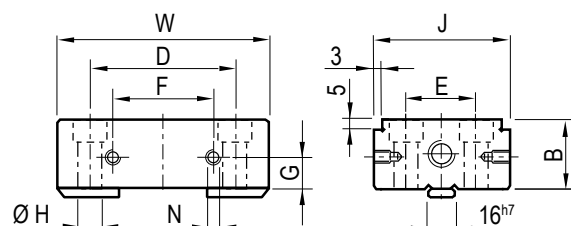
**Art. 805** (Montata su Art. 860)  
 (Assembled on Art. 860)

**Art. 805N** (Montata su Art. 863)  
 (Assembled on Art. 863)

**Art. 8050** Ganasia fissa con gradino piccolo e grande  
 Fixed jaw with small and large step

**Art. 805F** (Montata su Art. 866)  
 (Assembled on Art. 866)

## Tipo (grandezza) morsa / Vise (type) size

mm	1	2	3	4	5	6	Tolleranze / Tolerance
W	74	94	124	144	169	189	-
J	56	64	84	98	108	108	-0,02
J1	24	24	30	38	38	38	-
J2	16	16	16	16	16	16	-
B	25	30	40	50	60	60	-0,02
D	56	70	92	108	126	144	-
E	32	40	50	60	68	68	-
F	40	50	65	65	65	100	-
G	10	10	15	20	25	25	-
H	9	11	13	17	17	22	-
I	12,5	15	20	25	30	30	-0,02
N	M5	M6	M6	M6	M6	M6	-



## Tipo (grandezza) / Type (size)

		1	2	3	4	5	6
<b>Art. 805D</b>		Cod. 5.80.5D100	5.80.5D200	5.80.5D300	5.80.5D400	5.80.5D500	5.80.5D600
Ganascia fissa con gradino 3x5 zigrinata da un lato Fixed jaw with 3x5 step on side serrated							
<b>Art. 805E</b>		Cod. 5.80.5E100	5.80.5E200	5.80.5E300	5.80.5E400	5.80.5E500	5.80.5E600
Ganascia fissa con gradino 3x5 liscia Fixed jaw with 3x5 step smooth							
<b>Art. 805F</b>		Cod. 5.80.5F100	5.80.5F200	5.80.5F300	5.80.5F400	5.80.5F500	5.80.5F600
Ganascia fissa con doppio gradino 3x5 liscia Fixed jaw with double 3x5 step smooth							
<b>Art. 805G</b>		Cod. 5.80.5G100	5.80.5G200	5.80.5G300	5.80.5G400	5.80.5G500	5.80.5G600
Ganascia fissa con doppio gradino 3x5 zigrinata Fixed jaw with double 3x5 step serrated							
<b>Art. 805H</b>		Cod. 5.80.5H100	5.80.5H200	5.80.5H300	5.80.5H400	5.80.5H500	5.80.5H600
Ganascia fissa con prisma verticale Fixed jaw with vertical prism							
<b>Art. 805I</b>		Cod. 5.80.5I100	5.80.5I200	5.80.5I300	5.80.5I400	5.80.5I500	5.80.5I600
Ganascia fissa con doppio prisma verticale Fixed jaw with double vertical prism							
<b>Art. 805J</b>		Cod. 5.80.5J100	5.80.5J200	5.80.5J300	5.80.5J400	5.80.5J500	5.80.5J600
Ganascia fissa con prisma orizzontale Fixed jaw with horizontal prism							
<b>Art. 805K</b>		Cod. 5.80.5K100	5.80.5K200	5.80.5K300	5.80.5K400	5.80.5K500	5.80.5K600
Ganascia fissa con doppio prisma orizzontale Fixed jaw with double horizontal prism							
<b>Art. 805L</b>		Cod. 5.80.5L100	5.80.5L200	5.80.5L300	5.80.5L400	5.80.5L500	5.80.5L600
Ganascia fissa con gradino Step fixed jaw							
<b>Art. 805M</b>		Cod. 5.80.5M100	5.80.5M200	5.80.5M300	5.80.5M400	5.80.5M500	5.80.5M600
Ganascia fissa con gradino zigrinata da un lato Step fixed jaw one side serrated							
<b>Art. 805N</b>		Cod. 5.80.5N100	5.80.5N200	5.80.5N300	5.80.5N400	5.80.5N500	5.80.5N600
Ganascia fissa con doppio gradino Fixed jaw with double step							
<b>Art. 805O</b>		Cod. 5.80.5O100	5.80.5O200	5.80.5O300	5.80.5O400	5.80.5O500	5.80.5O600
Ganascia fissa con gradino piccolo e grande liscia da un lato Fixed jaw with small and large step on side smooth							
<b>Art. 805P</b>		Cod. 5.80.5P100	5.80.5P200	5.80.5P300	5.80.5P400	5.80.5P500	5.80.5P600
Ganascia fissa con gradino piccolo e grande zigrin. da un lato Fixed jaw with small and large step one side serrated							
<b>Art. 805Q</b>		Cod. 5.80.5Q100	5.80.5Q200	5.80.5Q300	5.80.5Q400	5.80.5Q500	5.80.5Q600
Ganascia fissa doppia con gradino piccolo e grande Double fixed jaw with small and large step							
<b>Art. 805R</b>		Cod. 5.80.5R100	5.80.5R200	5.80.5R300	5.80.5R400	5.80.5R500	5.80.5R600
Ganascia fissa in alluminio Fixed jaw aluminium							
<b>Art. 805T</b>		Cod. 5.80.5T100	5.80.5T200	5.80.5T300	5.80.5T400	5.80.5T500	5.80.5T600
Ganascia fissa doppia GRIP per forti serraggi GRIP Double fixed jaw for strongest clamping							
<b>Art. 805DT</b>		Cod. 5.80.5DT10	5.80.5DT20	5.80.5DT30	5.80.5DT40	5.80.5DT50	5.80.5DT60
Ganascia fissa a coda di rondine Dove tail fixed jaw							

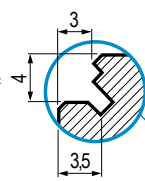

Richiedere scheda tecnica - Technical data sheet on request

# GANASCE MOBILI PER MORSE FMS

## MOVABLE JAWS FOR FMS VISES

Tipo (grandezza) / Type (size)	1	2	3	4	5	6
<b>Art. 810</b> Ganascia mobile zigrinata da un lato Movable jaw one side serrated	Cod. 5.81.01000	5.81.02000	5.81.03000	5.81.04000	5.81.05000	5.81.06000
<b>Art. 810A</b> Ganascia mobile liscia Smooth movable jaw	Cod. 5.81.0A100	5.81.0A200	5.81.0A300	5.81.0A400	5.81.0A500	5.81.0A600
<b>Art. 810B</b> Ganascia mobile dolce Soft movable jaw	Cod. 5.81.0B100	5.81.0B200	5.81.0B300	5.81.0B400	5.81.0B500	5.81.0B600
<b>Art. 810D</b> Ganascia mobile con gradino 3x5 zigrinata da un lato Movable jaw with 3x5 step on side serrated	Cod. 5.81.0D100	5.81.0D200	5.81.0D300	5.81.0D400	5.81.0D500	5.81.0D600
<b>Art. 814</b> Base mobile per ganasce fisse Movable base for fixed jaws	Cod. 5.81.41000	5.81.42000	5.81.43000	5.81.44000	5.81.45000	5.81.46000

Predisposizione per tutte le ganasce FMS fisse - Fit all FMS fixed jaws

**Art. 810** (Montata su Art. 860) / (Assembled on Art. 860)

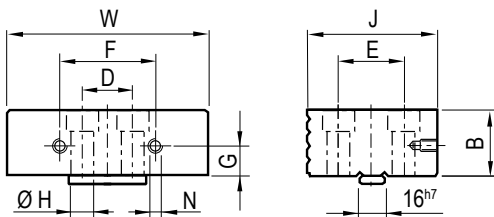

**Art. 8100** Ganascia mobile con gradino piccolo e grande  
Movable jaw with small and large step

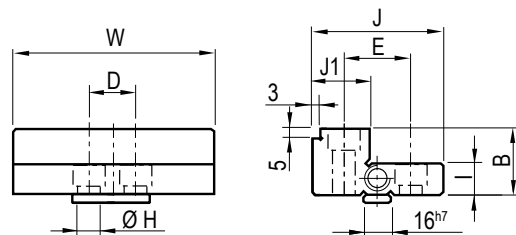

**Art. 810J** (Montata su Art. 870) / (Assembled on Art. 870)

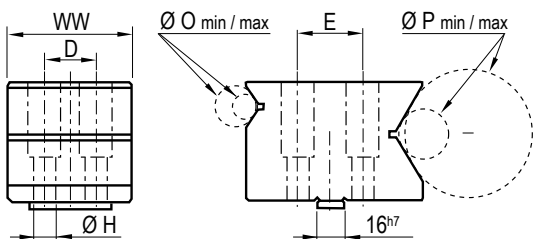

**Art. 814** Base mobile per ganasce fisse - Movable base for fixed jaws

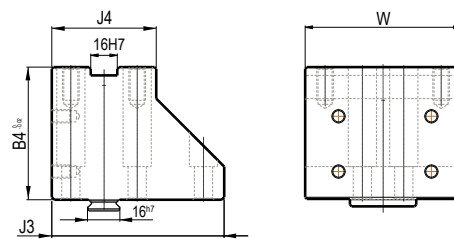

Tipo / Type	1 x 200	1 x 300	2	3	4	5	6	Tolleranze / Tolerance
W	74		94	124	144	169	189	-
WW	60		75	100	132	140	160	-
B	25		30	40	50	60	60	-0,02
B4	60		80	90	110	120	160	-0,02
D	20		25	38	44	44	54	-
E	26	32	40	50	60	68	68	-
F	40		50	65	65	65	100	-
G	10		10	15	20	25	25	-
H	9		11	13	17	17	22	-
I	12,5		15	20	25	30	30	-0,02
J	56		64	82	98	108	108	-0,02
J1	24		24	30	38	38	38	-0,02
J3	76	76	104	134	158	169	189	-
J4	55		63	83	97	106	107	-
N	M5		M6	M6	M6	M6	M6	-
Ø O	10 / 15		20 / 30	25 / 30	20 / 60	35 / 70	40 / 80	-
Ø P	10 / 25		20 / 50	40 / 100	45 / 150	63 / 200	73 / 300	-

Tipo (grandezza) / Type (size)		1	2	3	4	5	6	
<b>Art. 810E</b>	Ganascia mobile con gradino 3x5 liscia Movable jaw with 3x5 step smooth		Cod. 5.81.0E100	5.81.0E200	5.81.0E300	5.81.0E400	5.81.0E500	5.81.0E600
<b>Art. 810J</b>	Ganascia mobile prismatica per tondi liscia Prismatic movable jaw for round parts smooth		Cod. 5.81.0J100	5.81.0J200	5.81.0J300	5.81.0J400	5.81.0J500	5.81.0J600
<b>Art. 810K</b>	Ganascia mobile prismatica per tondi zigrinata Prismatic movable jaw for round parts serrated		Cod. 5.81.0K100	5.81.0K200	5.81.0K300	5.81.0K400	5.81.0K500	5.81.0K600
<b>Art. 810L</b>	Ganascia mobile con gradino Step movable jaw		Cod. 5.81.0L100	5.81.0L200	5.81.0L300	5.81.0L400	5.81.0L500	5.81.0L600
<b>Art. 810M</b>	Ganascia mobile con gradino zigrinata da un lato Step movable jaw one side serrated		Cod. 5.81.0M100	5.81.0M200	5.81.0M300	5.81.0M400	5.81.0M500	5.81.0M600
<b>Art. 8100</b>	Ganascia mobile con gradino piccolo e grande Movable jaw with small and large step		Cod. 5.81.0O100	5.81.0O200	5.81.0O300	5.81.0O400	5.81.0O500	5.81.0O600
<b>Art. 810P</b>	Ganascia mobile con gradino piccolo e grande zigrin. da un lato Movable jaw with small and large step one side serrated		Cod. 5.81.0P100	5.81.0P200	5.81.0P300	5.81.0P400	5.81.0P500	5.81.0P600
<b>Art. 810R</b>	Ganascia mobile in alluminio Movable jaw aluminium		Cod. 5.81.0R100	5.81.0R200	5.81.0R300	5.81.0R400	5.81.0R500	5.81.0R600
<b>Art. 810T</b>	Ganascia mobile GRIP per forti serraggi GRIP movable jaw for strongest clamping	 	Cod. 5.81.0T100	5.81.0T200	5.81.0T300	5.81.0T400	5.81.0T500	5.81.0T600
<b>Art. 810DT</b> <b>NEW!</b>	Ganascia mobile a coda di rondine Dove tail movable jaw	 	Cod. 5.81.0DT10	5.81.0DT20	5.81.0DT30	5.81.0DT40	5.81.0DT50	5.81.0DT60
Richiedere scheda tecnica - Technical data sheet on request								
<b>Art. 810V</b>	Ganascia mobile con segmenti oscillanti Movable jaw with floating inserts		Cod. 5.81.0V100	5.81.0V200	5.81.0V300	5.81.0V400	5.81.0V500	5.81.0V600
<b>Art. 512</b>	Ganascia intermedia Intermediate Jaw		Cod. 5.51.21000	5.51.22000	5.51.23000	5.51.24000	5.51.25000	5.51.26000

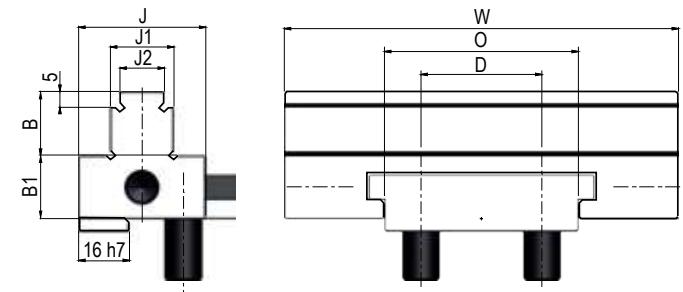
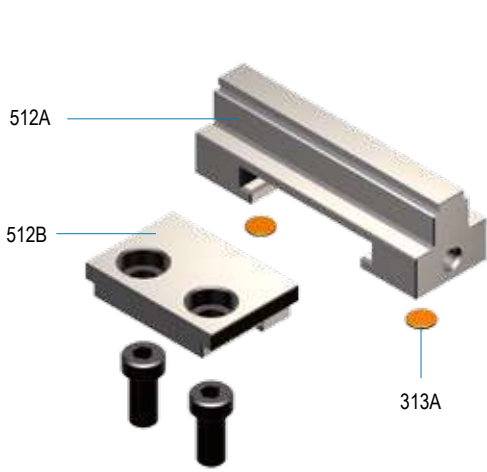

Tipo / Type	1	2	3	4	5	6
W	74	94	124	144	169	189
J	25	35	40	40	50	50
J1	15	15	20	20	30	30
J2	9	9	14	14	19	19
B / B1	12,5	15	20	25	30	30
D	20	25	38	44	44	54
O	34	40	60	70	81	93

Vedi esempio applicativo - See application example: Pag. 5.15

# PIASTRE GANASCE PIANE CON INSERTI GRIP PER MORSE FMS STRAIGHT INSERT GRIP JAW PLATES FOR FMS VISES

**NEW!**

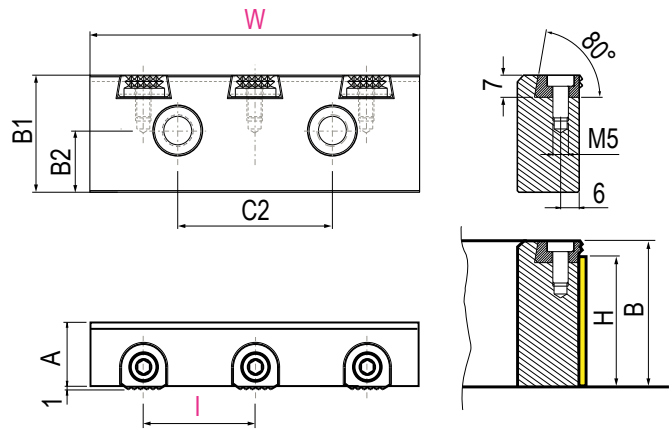
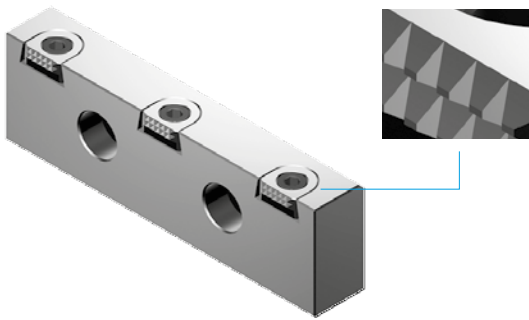

**Art.547G** Piastra Piana con inserti GRIP per morse FMS  
FMS vises Straight plate with GRIP inserts

Tipo / Type	1	2	3	4	5	6
W	74	94	124	144	169	189
I	25	32	23,5	29,5	23,5	27
C2	40	50	65	65	65	100
B	25	30	40	50	60	60
B1	25	30	40	50	60	60
B2	10	10	15	20	25	25
A	14	20	24	24	29	35
H	20	25	35	45	55	55
Cod.	5.54.7G100	5.54.7G200	5.54.7G300	5.54.7G400	5.54.7G500	5.54.7G600

**Art. 220 G01**

Per materiali di durezza normale  
For standard workpieces hardness clamping

Cod. 4.22.01000 / G01

**Art. 220 G02**

Per materiali di notevole durezza.  
For hardened workpieces clamping

Cod. 4.22.01000 / G02

**Art. 220 G11**

Per materiali teneri  
For soft material clamping

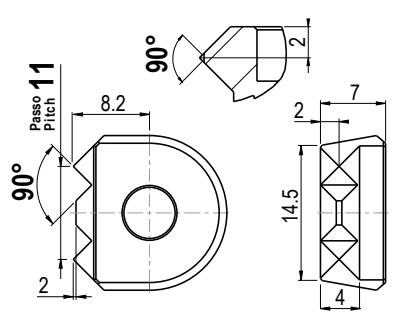
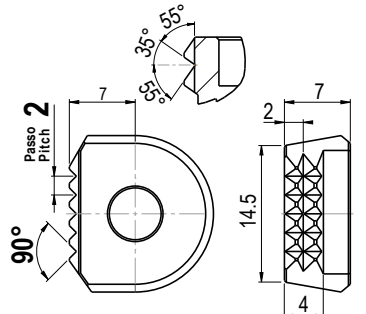
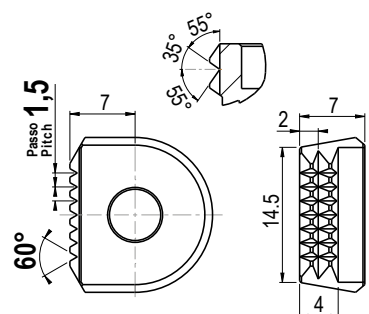

Cod. 4.22.01000 / G11



Tipo / Type	1	2	3	4	5	6
Art.547G						
	3 pcs each	3 pcs each	5 pcs each	5 pcs each	7 pcs each	7 pcs each

# PIASTRE PER MORSE FMS

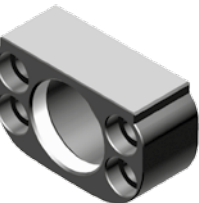
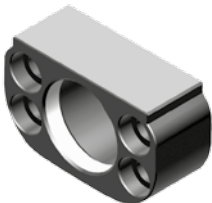
## PLATES FOR FMS VISES

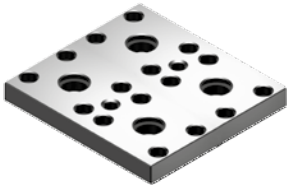
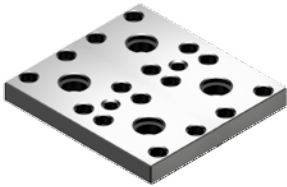
Tipo (grandezza) / Type (size)	1	2	3	4	5	6
<b>Art. 823</b> Piastra intermedia per Art. 855 Middle plate for Art. 855						
	Cod.	5.82.31000	5.82.32000	5.82.33000	5.82.34000	5.82.35000
<b>Art. 823B</b> Piastra intermedia per Art. 800 Middle plate for Art. 800						
	Cod.	5.82.3B100	5.82.3B200	5.82.3B300	5.82.3B400	5.82.3B500
<b>Art. 825</b> Piastra di contenimento vite per morse FMS per Art. 855 Screw holding plate for FMS vise for Art. 855						
	Cod.	5.82.51000	5.82.52000	5.82.53000	5.82.54000	5.82.55000
<b>Art. 825B</b> Piastra di contenimento vite per morse FMS per Art. 800 Screw holding plate for FMS vise for Art. 800						
	Cod.	5.82.5B100	5.82.5B200	5.82.5B300	5.82.5B400	5.82.5B500
<b>Art. 825C</b> Piastra di contenimento vite per morse FMS per Art. 855W Screw holding plate for FMS vise for Art. 855W						
	Cod.	5.82.5C100	5.82.5C200	5.82.5C300	5.82.5C400	5.82.5C500
<b>Art. 831</b> Piastra di collegamento per 2 morse FMS montate verticalmente dorso a dorso o fianco a fianco Connecting plate for 2 FMS vises vertically mounted back-to-back or side by side						
	Cod.	5.83.11000	5.83.12000	5.83.13000	5.83.14000	5.83.15000
<b>Art. 832</b> Piastra di collegamento per 4 morse FMS montate verticalmente dorso a dorso o fianco a fianco Connecting plate for 4 FMS vises vertically mounted back-to-back or side by side						
	Cod.	5.83.21000	5.83.22000	5.83.23000	5.83.24000	5.83.25000
<b>Art. 833</b> Piastra di collegamento personalizzata per 2 morse FMS Connecting plate for 2 FMS vises tailor made						
	Cod.	5.83.31000	5.83.32000	5.83.33000	5.83.34000	5.83.35000
<b>Art. 834</b> Piastra di collegamento personalizzata per 4 morse FMS Connecting plate for 4 FMS vises tailor made						
	Cod.	5.83.41000	5.83.42000	5.83.43000	5.83.44000	5.83.45000



# PIASTRE BASE PER MORSE FMS

## BASE PLATES FOR FMS VISES

Tipo (grandezza) / Type (size)	1	2	3	4	5	6	7
<b>Art. 827</b> Piastra base per una o più morse Head plate for one or more vises	C	33	33	38	38	38	38
	H	300	350	400	450	500	630
	Kg	22	30	44	56	71	113
	Cod.	5.82.71000	5.82.72000	5.82.73000	5.82.74000	5.82.75000	5.82.76000

<b>Art. 827A</b> Piastra base personalizzata per una o più morse Bussola di centraggio Art. 852 compresa Tailor made head plate for one or more vises Centering bushing Art. 852 included	Kg	21,5	29,5	43,5	55	70	112
	Cod.	5.82.7A100	5.82.7A200	5.82.7A300	5.82.7A400	5.82.7A500	5.82.7A600

<b>Art. 828</b> Piastra base per cubo morsa Head plate for vise tower	Kg	22,5	30,5	45	57	72	114
	Cod.	5.82.81000	5.82.82000	5.82.83000	5.82.84000	5.82.85000	5.82.86000

<b>Art. 828A</b> Piastra base personalizzata per cubo morsa Bussola di centraggio Art. 852 compresa Tailor made head plate for vise tower Centering bushing Art. 852 included	Kg	22	30	44,5	56,5	71	113
	Cod.	5.82.8A100	5.82.8A200	5.82.8A300	5.82.8A400	5.82.8A500	5.82.8A600

Tipo (grandezza) / Type (size)	1	2	3	4	5	6
<b>Art. 835</b> Distanziale quadrato per 4 morse FMS Square spacer for 4 FMS vises	A	75	95	125	145	170
	Cod.	5.83.51000	5.83.52000	5.83.53000	5.83.54000	5.83.55000

<b>Art. 836</b> Supporto quadrato per 4 morse FMS Square support for 4 FMS vises	A	75	95	125	145	170
	B	200	300	400	500	600
	Cod.	5.83.61000	5.83.62000	5.83.63000	5.83.64000	5.83.65000

<b>Art. 837</b> Supporto esagonale per 6 morse FMS Exagon support for 6 FMS vises	B	200	300	400	500	600
	C	132	170	220	255	300
	D	76 ~	98 ~	127 ~	147 ~	173 ~
	Cod.	5.83.71000	5.83.72000	5.83.73000	5.83.74000	5.83.75000

<b>Art. 838</b> Distanziale esagonale per 6 morse FMS Exagon spacer for 6 FMS vises	C	132	170	220	255	300
	D	76 ~	98 ~	127 ~	147 ~	173 ~
	Cod.	5.83.81000	5.83.82000	5.83.83000	5.83.84000	5.83.85000

<b>Art. 852</b> Bussola di centraggio per piastra base Centering bushing for base plate	Cod.	5.85.21000	5.85.22000	5.85.23000	5.85.24000	5.85.25000

<b>Art. 853</b> Centraggio orizzontale per cubo FMS Horizontal centering for FMS cube	Cod.	5.85.31000	5.85.32000	5.85.33000	5.85.34000	5.85.35000

Tipo (grandezza) / Type (size)	1	2	3	4	5	6
--------------------------------	---	---	---	---	---	---

**Art. 825A**

 Ghiera per morse e cubi FMS  
 Nut for FMS vises and cubes

Cod.	5.82.5A100	5.82.5A200	5.82.5A300	5.82.5A400	5.82.5A500	5.82.5A600

**Art. 850B**

 Riparo lato vite  
 Protection side screw

Cod.	5.85.0B100	5.85.0B200	5.85.0B300	5.85.0B400	5.85.0B500	5.85.0B600

**Art. 850C**

 Riparo  
 Protection



Cod.	5.85.0C100	5.85.0C200	5.85.0C300	5.85.0C400	5.85.0C500	5.85.0C600

**Art. 850P**

 Dispositivo "Terza Mano"  
 "Third Hand" device

Cod.	5.85.0P100	5.85.0P200	5.85.0P300	5.85.0P400	5.85.0P500	5.85.0P600

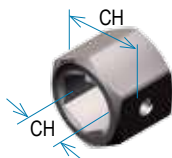
**Art. 850E**

 Bussola esagonale per innesto automatico  
 Hexagonal bushing for automatic connection

CH	12 / 22	14 / 24	19 / 30	19 / 30	27 / 40	27 / 40
Cod.	5.85.0E100	5.85.0E200	5.85.0E300	5.85.0E400	5.85.0E500	5.85.0E600

**Art. 850T**

 Distanziale per morsa solo autocentrante  
 Spacer for Self-centering vise only

Cod.	5.85.0T100	5.85.0T200	5.85.0T300	5.85.0T400	5.85.0T500	5.85.0T600

**Art. 850H**

 Chiave esagonale per morsa FMS e cubo  
 Hexagonal wrench for FMS vise and cube

Cod.	5.85.0H100	5.85.0H200	5.85.0H300	5.85.0H500

**Art. 801S**

 Piastrina di collegamento slitte morsa  
 Slides vise connecting plate

Cod.	5.80.1S100	5.80.1S200	5.80.1S300	5.80.1S400	5.80.1S600

**RICAMBI PER MORSE Art.800**  
**SPARE PARTS FOR VISES Art.800**
**Art. 800E**

 Guarnizione per slitta integrale  
 O ring for solid slide

Cod.	5.80.0E100	5.80.0E200	5.80.0E300	5.80.0E400	5.80.0E500	5.80.0E600

**Art. 801G**

 Grano di bloccaggio protezione centrale  
 Setscrew for clamping central protection

Cod.	5.80.1G100	5.80.1G200	5.80.1G300	5.80.1G400	5.80.1G500	5.80.1G600

**Art. 800I**

 Vite tcei per piastra di contenimento  
 Hex.socket head screw for screw holding plate

Cod.	5.80.0I100	5.80.0I200	5.80.0I300	5.80.0I400	5.80.0I500	5.80.0I600
Cod.	5.80.1H100	5.80.1H200	5.80.1H300	5.80.1H400	5.80.1H500	5.80.1H600
Cod.	5.80.1I100	5.80.1I200	5.80.1I300	5.80.1I400	5.80.1I500	5.80.1I600

**Art. 801H**

 Vite tcei per ganasce a gradino  
 Hex.socket head screw for step jaws

**Art. 801I**

 Vite tcei per ganasce  
 Hex.socket head screw for jaws

# SERVOCOMANDI OLEODINAMICI PER MOTORI IDRAULICI ELECTRO-HYDRAULIC POWER PACK FOR HYDRAULIC MOTORS

Tipo (grandezza) / Type (size)	1	2	3	4	5	6
<b>Art. 566</b> Motore idraulico / Hydraulic motor	OMM32	OMP80	OMR200	OMR200	OMR200	OMR200
bar	140					
A mm	75	130	123	145	168	188
B mm	70	100	104	119	139	159
C mm	157	234	244	246	261	261
Cod.	5.89.01000	5.89.02000	5.89.03000	5.89.04000	5.89.05000	5.89.06000

## Art.890

**Art. 566 + Art. 571 + Art. 891 + Art. 892**

Motore idraulico completo di piastra d' interfaccia, boccola e fine corsa elettronico regolabile  
Hydraulic motor complete with connecting plate, bushing and adjustable electronic proximity switch

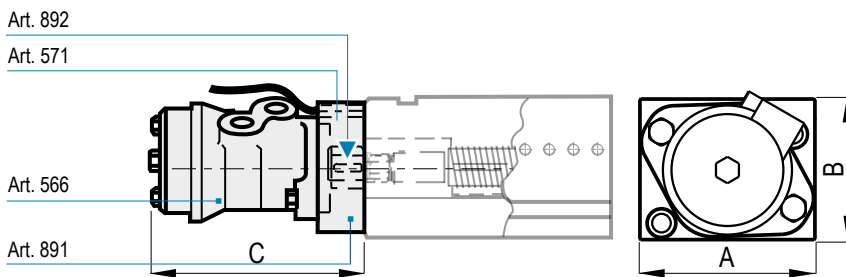

## Art. 891

Piastra attacco motore idraulico / Hydraulic motor mounting plate

Cod.	5.89.11000	5.89.12000	5.89.13000	5.89.14000	5.89.15000	5.89.16000
------	------------	------------	------------	------------	------------	------------

## Art. 892

Boccola di trascinamento vite motore / Drive bushing screw-motor

Cod.	5.89.21000	5.89.22000	5.89.23000	5.89.24000	5.89.25000	5.89.26000
------	------------	------------	------------	------------	------------	------------

## Art. 566

Motore Idraulico / Hydraulic motor

Cod.	5.56.61000	5.56.62000	5.56.63000	5.56.63000	5.56.63000	5.56.63000
------	------------	------------	------------	------------	------------	------------

## Art. 571

Fine corsa elettronico / Electronic proximity switch

Cod.	5.57.11000	5.57.12000	5.57.13000	5.57.14000	5.57.15000	5.57.16000
------	------------	------------	------------	------------	------------	------------

Tipo (grandezza) / Type (size)	1	2	3	4	5	6
--------------------------------	---	---	---	---	---	---

## Art.890K/1

**Art. 266B + Art. 890**

Kit per automazione morse FMS  
Kit for FMS vises automation.

bar	130	100	100	100	120	120
-----	-----	-----	-----	-----	-----	-----

l/min	5	10	20	20	20	20
-------	---	----	----	----	----	----

Cod.	5.89.0K101	5.89.0K201	5.89.0K301	5.89.0K401	5.89.0K501	5.89.0K601
------	------------	------------	------------	------------	------------	------------

### COMPOSIZIONE COMPLETA DI:

- N° 1 servocomando Art. 890
- N° 1 centralina elettroidraulica Art. 266B/1
- Comando manuale elettrico da pulsantiera con chiusura ed apertura indipendente, singola o simultanea vedi pag. 5.79
- Regolazione forza di bloccaggio desiderata
- Fine corsa elettronico regolabile

### COMPOSITION COMPLETE OF:

- N° 1 hydraulic servo unit Art. 890
- N° 1 electro-hydraulic power pack Art. 266B/1
- Electrically controlled by manual switch board see pag. 5.79
- Adjustable clamping force as required
- Adjustable electronic proximity switch

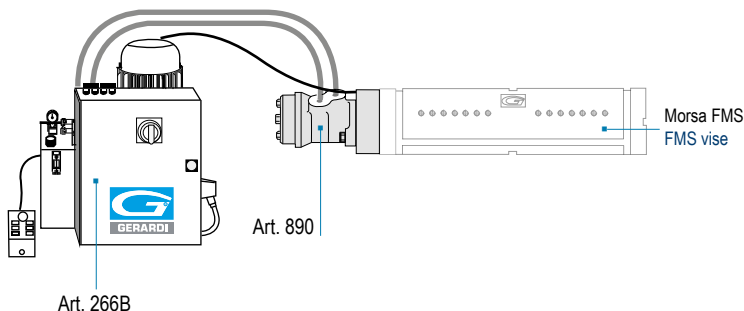

### DATI TECNICI:

Velocità apertura-chiusura morse da calcolarsi in base al diagramma idromotore (Vedi pag 5.65)

Per il diagramma forza di serraggio vedi pag. 5.72  
Pressione massima di esercizio: 140 bar

### TECHNICAL DATA:

Opening and closing speed of vise to be calculated from hydraulic motor diagram at page 5.65

For clamping forces diagram see pag. 5.72  
Max operating pressure: 140 bar

Tubi e cavi di collegamento elettrici ed idraulici con massima lunghezza 1600 mm / Hydraulic pipes and electrical cables with max length 1600 mm

# SERVOCOMANDI OLEODINAMICI PER MOTORI IDRAULICI ELECTRO-HYDRAULIC POWER PACK FOR HYDRAULIC MOTORS

Tipo (grandezza) / Type (size)	1	2	3	4	5	6
<b>Art. 890K/2</b>						
bar	130	100	100	100	120	120
l/min	10	20	40	40	40	40
Cod.	5.89.0K102	5.89.0K202	5.89.0K302	5.89.0K402	5.89.0K502	5.89.0K602

**Art. 266B + 2 Art. 890**

Kit per automazione morse FMS  
Kit for FMS vises automation.

COMPOSIZIONE COMPLETA DI:

- N° 2 servocomandi Art. 890
- N° 1 centralina elettroidraulica Art. 266B/2
- Comando manuale elettrico da pulsantiera con chiusura ed apertura indipendente, singola o simultanea
- Regolazione forza di bloccaggio desiderata
- Fine corsa elettronico regolabile

COMPOSITION COMPLETE OF:

- N° 2 hydraulic servo unit Art. 890
- N° 1 electro-hydraulic power pack Art. 266B/2
- Electrically controlled by manual switch board
- Adjustable clamping force as required
- Adjustable electronic proximity switch

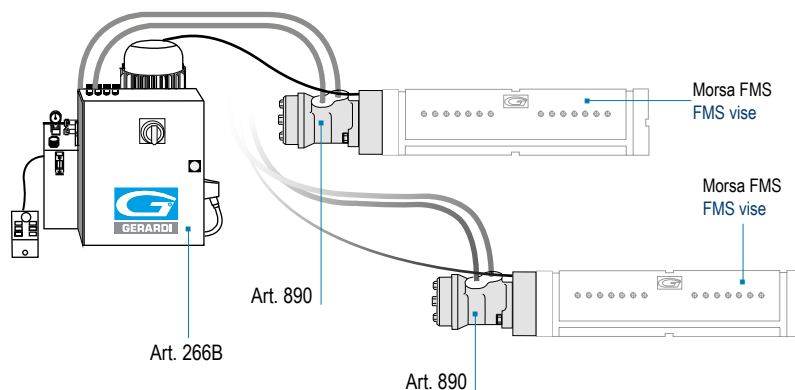

DATI TECNICI:

Velocità apertura-chiusura morsa da calcolarsi in base al diagramma idromotore (Vedi pag 5.65)  
Per il diagramma forza di serraggio vedi pag. 5.72  
Pressione massima di esercizio: 140 bar

TECHNICAL DATA:

Opening and closing speed of vise to be calculated from hydraulic motor diagram at page 5.65  
For clamping forces diagram see pag. 5.72  
Max operating pressure: 140 bar

Tubi e cavi di collegamento elettrici ed idraulici con massima lunghezza 1600 mm / Hydraulic pipes and electrical cables with max lenght 1600 mm

Tipo (grandezza) / Type (size)	1	2	3	4	5	6
<b>Art. 890K/3</b>						
bar	130	100	100	100	120	120
l/min	15	30	60	60	60	60
Cod.	5.89.0K103	5.89.0K203	5.89.0K303	5.89.0K403	5.89.0K503	5.89.0K603

**Art. 266B + 3 Art. 890**

Kit per automazione morse FMS  
Kit for FMS vises automation.

COMPOSIZIONE COMPLETA DI:

- N° 3 servocomandi Art. 890
- N° 1 centralina elettroidraulica Art. 266B/4
- Comando manuale elettrico da pulsantiera con chiusura ed apertura indipendente, singola o simultanea
- Regolazione forza di bloccaggio desiderata
- Fine corsa elettronico regolabile

COMPOSITION COMPLETE OF:

- N° 3 hydraulic servo unit Art. 890
- N° 1 electro-hydraulic power pack Art. 266B/4
- Electrically controlled by manual switch board
- Adjustable clamping force as required
- Adjustable electronic proximity switch

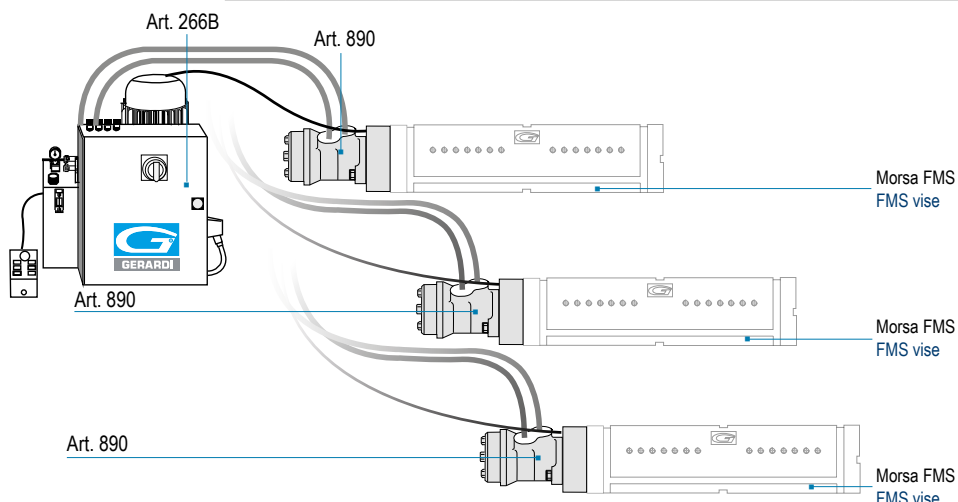

DATI TECNICI:

Velocità apertura-chiusura morsa da calcolarsi in base al diagramma idromotore (Vedi pag 5.65)  
Per il diagramma forza di serraggio vedi pag. 5.72  
Pressione massima di esercizio: 140 bar

TECHNICAL DATA:

Opening and closing speed of vise to be calculated from hydraulic motor diagram at page 5.65  
For clamping forces diagram see pag. 5.72  
Max operating pressure: 140 bar

Tubi e cavi di collegamento elettrici ed idraulici con massima lunghezza 1600 mm / Hydraulic pipes and electrical cables with max lenght 1600 mm

# SERVOCOMANDI OLEODINAMICI PER MOTORI IDRAULICI ELECTRO-HYDRAULIC POWER PACK FOR HYDRAULIC MOTORS

Tipo (grandezza) / Type (size)	1	2	3	4	5	6
bar	130	100	100	100	120	120
l/min	20	40	80	80	80	80
Cod.	5.89.0K104	5.89.0K204	5.89.0K304	5.89.0K404	5.89.0K504	5.89.0K604

## Art. 890K/4

Art. 266B + 4 Art. 890

Kit per automazione morse FMS  
Kit for FMS vises automation.

### COMPOSIZIONE COMPLETA DI:

- N° 4 servocomandi Art. 890
- N° 1 centralina elettroidraulica Art. 266B/4
- Comando manuale elettrico da pulsantiera con chiusura ed apertura indipendente, singola o simultanea
- Regolazione forza di bloccaggio desiderata
- Fine corsa elettronico regolabile

### COMPOSITION COMPLETE OF:

- N° 4 hydraulic servo unit Art. 890
- N° 1 electro-hydraulic power pack Art. 266B/4
- Electrically controlled by manual switch board
- Adjustable clamping force as required
- Adjustable electronic proximity switch

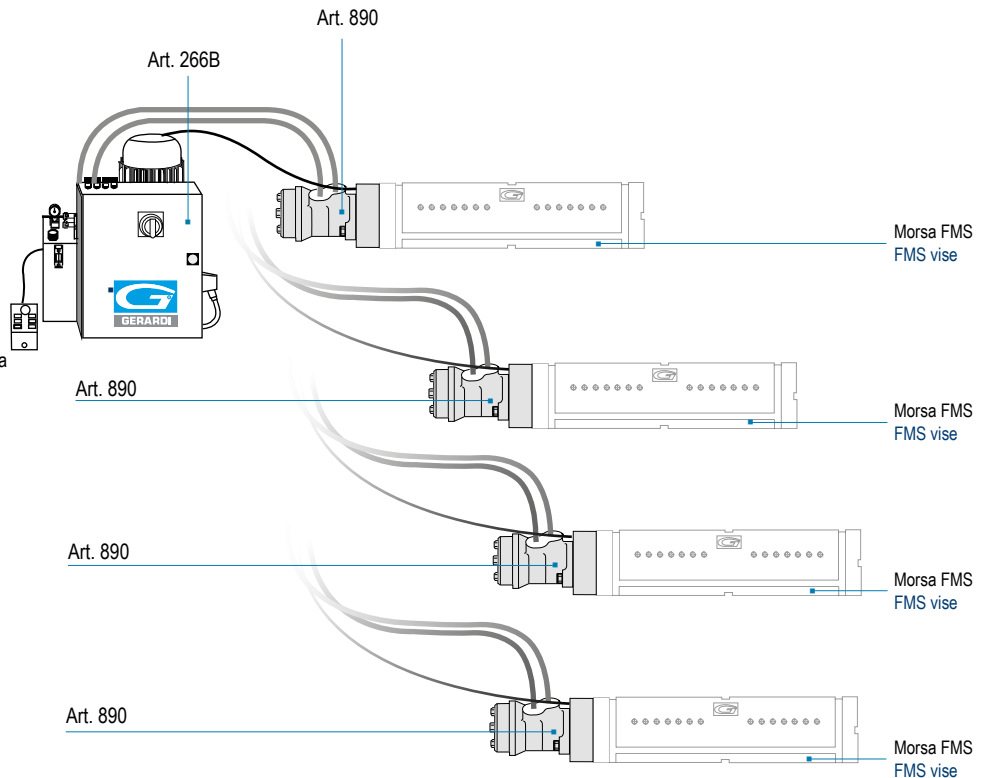

### DATI TECNICI:

Velocità apertura-chiusura morse da calcolarsi  
in base al diagramma idromotore (Vedi pag. 5.65)

Per il diagramma forza di serraggio vedi pag. 5.72  
Pressione massima di esercizio: 140 bar

### TECHNICAL DATA:

Opening and closing speed of vise to be calculated  
from hydraulic motor diagram at page 5.65

For clamping forces diagram see pag. 5.72  
Max operating pressure: 140 bar



Tubi e cavi di collegamento elettrici ed idraulici con massima lunghezza 1600 mm / Hydraulic pipes and electrical cables with max length 1600 mm



# GRAFICI MORSE FMS CON MOTORE IDRAULICO DIAGRAMS OF FMS VISES WITH HYDRAULIC MOTORS

## Art.890

(Art.890) Motore idraulico  
(Art.890) Hydraulic motor

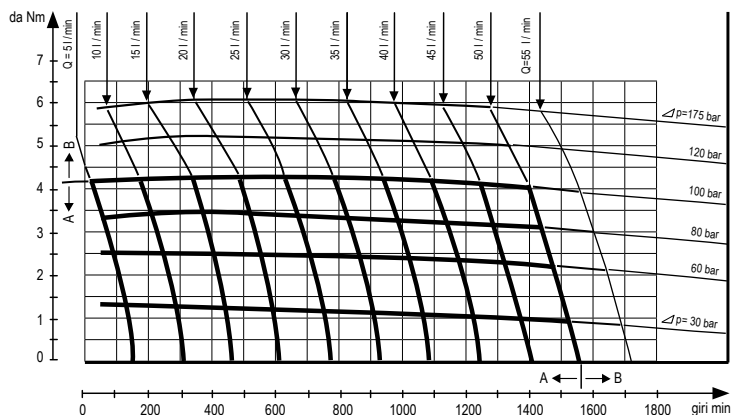
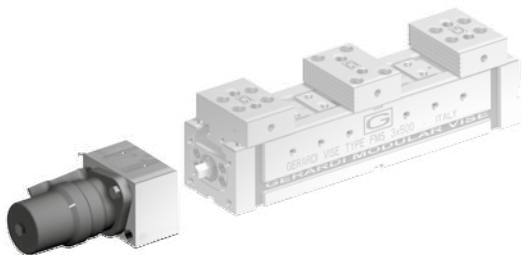

## OMM 32

Morse FMS tipo 1 / Type 1 FMS vises

## Art.890

(Art.890) Motore idraulico  
(Art.890) Hydraulic motor

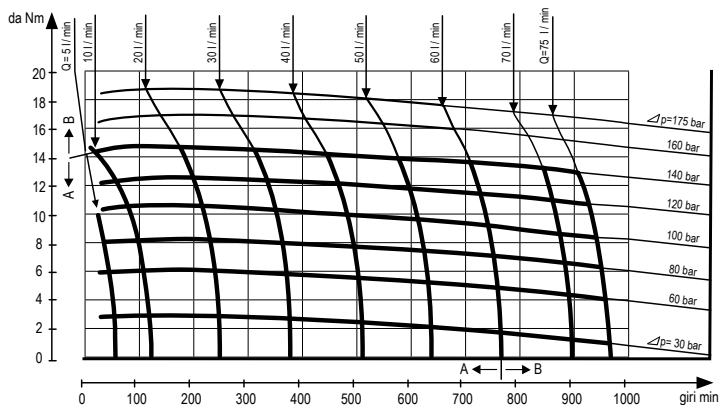
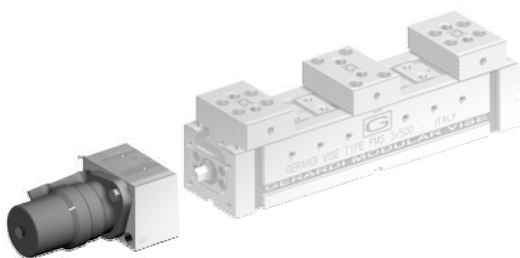

## OMP 80

Morse FMS tipo 2 / Type 2 FMS vises

## Art.890

(Art.890) Motore idraulico  
(Art.890) Hydraulic motor

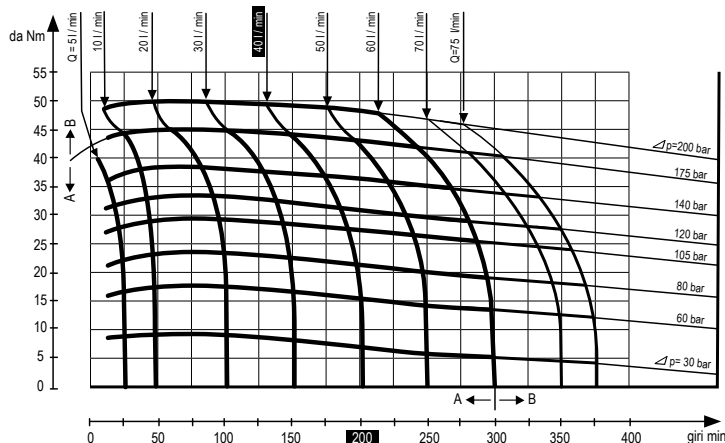
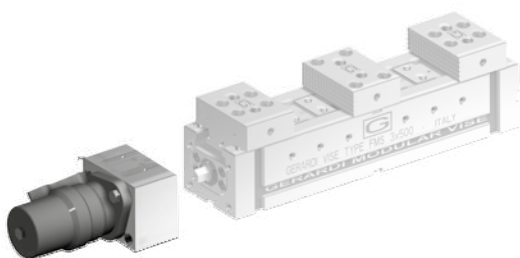

## OMR 200

Morse FMS tipo 3 - 4 - 5 - 6 Type 3 - 4 - 5 - 6 FMS vises

VELOCITA' = Passo vite x giri/min (dati dalla portata di olio in l/min) - 25% circa per attriti e resistenze varie.

Esempio: Vite passo 2 mm; Giri 200/min (ipotizzando una portata olio di 40 l/min);  $V = 2 \times 200 = 400 - 25\% = 300$  mm/min per una morsa.

Per più morse dividere la velocità ottenuta per il numero delle morse impiegate.

SPEED = Screw pitch x RPM (that you get from oil pump of 40 l/min) about - 25% for friction and other resistance.

Example: Screw pitch 2mm; RPM 200/min (taking in consideration oil pump of 40 l/min);  $V = 2 \times 200 = 400 - 25\% = 300$  mm/min for one vise.

For more vises divide the speed obtained by the number of vises used.

# DIVISORE AUTOMATICO DPG 250

## AUTOMATIC DIVIDING HEAD DPG 250

**NEW!**

 Divisore automatico  
 Automatic dividing head

 DATI TECNICI  
 TECHNICAL DATA

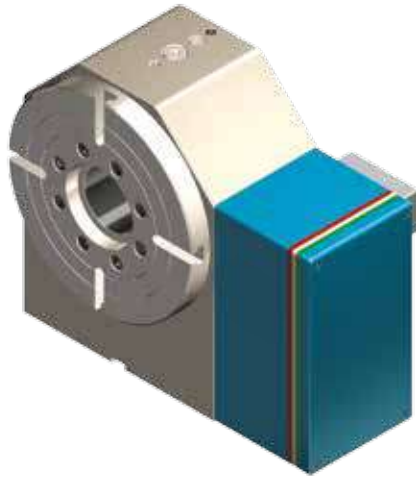
**DPG 250**

Diametro del divisore Dividing head diameter		250 mm
Diametro del foro passante Clearance hole diameter		70,5 mm
Altezza punta Center height		200 mm
Dimensione della scanalatura a T T-Slot width		12 mm
Sistema di bloccaggio Clamping system		Idrraulico Hydraulic
Forza frenante Clamping torque		3000 Nm
Motore Servo motor		3000 Max.g/min
Minimo incremento Minimum increment		0,002
Velocità di rotazione Rotation speed		33,3 Giri/min
Rapporti vite/corona Speed reduction ratio (screw/gear)		1/90
Rapporti vite/motore Speed reduction ratio (screw/motor)		1/180
Precisione Indexing accuracy		±10 Sec.
Ripetibilità Repeatability		4 Sec.
Max. carico di lavoro sul divisore Max. allowable work weight on the dividing head	Verticale Vertical	Kg.550
	Orizzontale Horizontal	Kg.1500
Max. carico di spinta applicabile sul divisore Max. allowable tool load on the dividing head		N 25000
		FxL Nm 1000
		FxL Nm 2200
Rapporti vite/corona Speed reduction ratio (screw/gear)	Verticale Vertical	10,5 Kg. m <sup>2</sup>
Coppia in lavoro Driving torque	Corona dentata Worm gear	698 Nm
Kg		110
Cod.		8.DP.G2500

**PROGRAMMAZIONE TOUCH SCREEN**  
 FACILE ED INTUITIVA O TRAMITE COLLEGAMENTO DIRETTO AL CNC

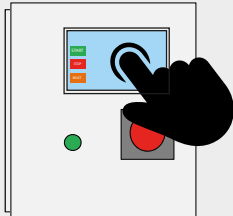
**EASY AND INTUITIVE TOUCH SCREEN**  
 PROGRAMMING OR THROUGH DIRECT CONNECTION TO THE CNC

- Installazione semplice (alimentazione 220V)
- Corona in bronzo speciale
- Controsupporto semplice
- Vite senza fine in acciaio temprato e rettificato
- Vite e corona in bagno d'olio
- Cuscinetti a vite precaricati
- Cuscinetto anteriore a rulli incrociati sovradimensionato
- Recupero gioco con avvicinamento assiale
- Completa tenuta stagna ai liquidi con possibilità di pressurizzazione
- Possibilità di montare motori di tutte le marche
- Dimensioni esterne contenute
- Finestra di controlli liquidi e condensa
- Lavorazione in posizionamento a 360°

- Easy installation (220V)
- Special bronze crown
- Simple tailstock
- Worm screw in hardened ground steel
- Bath lubrication Screw and Crown
- Pre-loaded screw bearings
- Over-dimensioned crossed-roller front bearing
- Play recover with axial approach
- Watertight seal with possibility of pressurization
- Possibility to mount motors of all brands
- Reduced external dimensions
- Condensation and liquid control window
- 360° work positioning

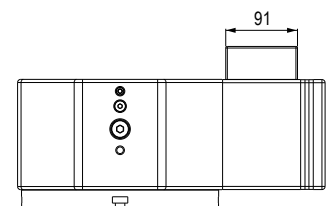
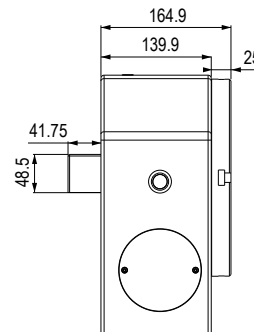
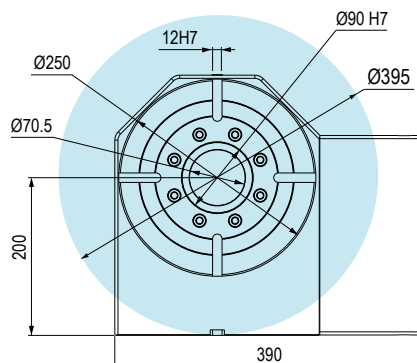
**DPG 250**

## Tipo (grandezza) morsa / Vise (type) size

 Divisore Gerardi **DPG250**  
 con cubo-morsa **FMS**  
 per serraggi singoli, doppi  
 o autocentranti

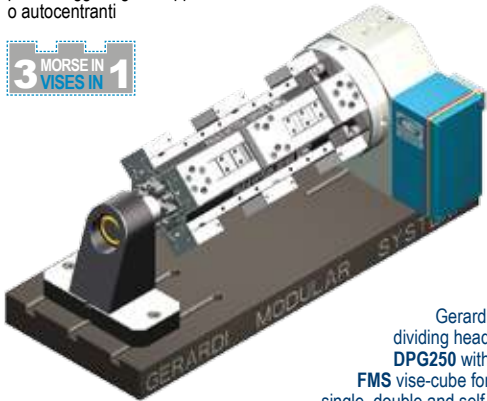
**3 MORSE IN  
 VISES IN 1**

 Gerardi  
 dividing head  
**DPG250** with  
**FMS** vise-cube for  
 single, double and self-  
 centering clamping

kN	1		2				3					
	25 kN		25 kN				30 kN					
D	200	300	300	400	500	600	400	500	600	700	800	
G1	120		175				210					
W	74		94				124					
kg	30	45	53	70	88	106	90	112	135	157	180	
Cod.	5.DP.G250000	5.DP.G25010	5.DP.G25020	5.DP.G25030	5.DP.G25040	5.DP.G25050	5.DP.G25060	5.DP.G25070	5.DP.G25080	5.DP.G25090	5.DP.G25011	

**AMPLIA LE TUE APPLICAZIONI TRAMITE GLI ACCESSORI MODULARI ! - UPGRADE YOUR APPLICATIONS THROUGH MODULAR ACCESSORIES !**
**Art. 99A**

 Supporto  
 Support

Cod. 5.99.A2000

**Art. 99B**

 Perno di centraggio orizzontale  
 Horizontal centering pin

Cod. 5.99.B1000 5.99.B2000 5.99.B3000

**Art. 99H**

 Distanziale  
 Spacer



Cod. 5.99.H2000

**Art. 62**
**DPG 250**

 Piastra di interfaccia DPG 250 per FMS  
 DPG 250 connecting plate for FMS

Cod. 5.62.804A05 5.62.804A06 5.62.804A07

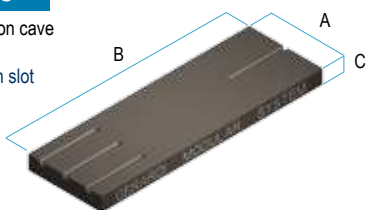
**Art. 99S**

 Piastra base con cave  
 Piani rettificati  
 Base plate with slot  
 Faces ground

Dimensioni B mm / Dimension B mm	A	C	Kg	Cod.	€
650	400	50	102	1.99.S065S	
950	400	50	149	1.99.S095S	
1250	400	50	195	1.99.S125S	

 Cave o fori calibrati su richiesta  
 Slot or calibrated holes on request

Disponibili quote "B" a step di 50mm - Available dimension "B" in steps of 50mm

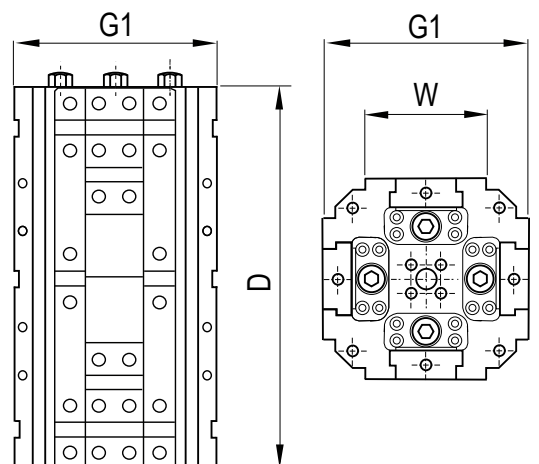
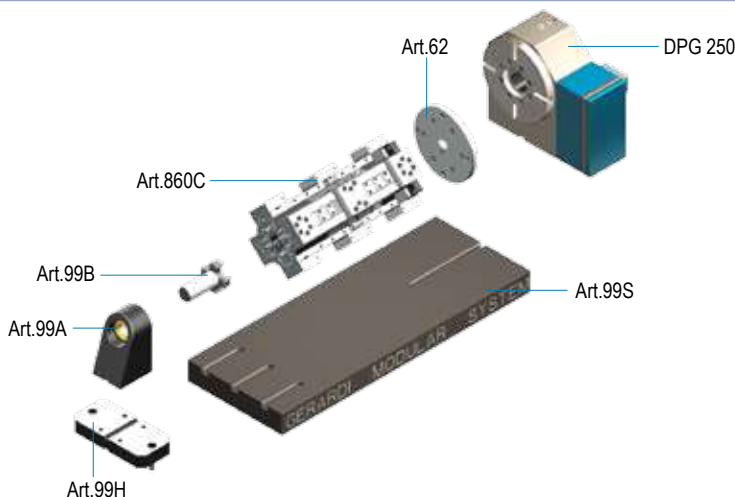

# DIVISORE MECCANICO DIVIGER 205

## MECHANICAL DIVIDING HEAD DIVIGER 205

 Divisore meccanico  
 Mechanical dividing head

 DATI TECNICI  
 TECHNICAL DATA

### DIVIGER 205



Diametro del divisore Dividing head diameter	220 mm
Diametro del foro passante Clearance hole diameter	85 mm
Altezza centrale Center height	200 mm
Dimensione della scanalatura a T T-Slot width	-
Sistema di bloccaggio Clamping system	Meccanico Mechanical
Minimo incremento Minimum increment	1°
Precisione Indexing accuracy	±10 Sec.
Coppia in lavoro Driving torque	 3000 Nm
Kg	93
Cod.	7.66.73000

**DIVISORE MECCANICO, SENZA CAVI O IDRAULICA, PERMACCHINE A CNC**

**MECHANICAL DIVIDING HEAD, WITHOUT ELECTRICAL CABLES OR HYDRAULIC, FOR CNC MILLING MACHINE**

- Maggiore efficienza nella lavorazione su più lati
- Completamente autonomo dalla macchina
- Elevato momento torcente
- Divisione manuale o automatica tramite mandrino macchina
- 360 posizioni
- Serraggio simultaneo di due particolari grazie alla doppia flangia
- lavorazione su 5 facce senza contropunta
- Lavorazione a barra grazie al mandrino cavo
- Utilizzabile orizzontalmente o verticalmente
- Cambio tramite serraggio a cuneo
- Cost-effective on multiple-sides machining
- Machine independent
- High holding torque
- Dividing manually or automatically using the machine spindle
- 360 x 1° division
- Simultaneous clamping of 2 workpieces thanks to the dual flange
- 5 faces machining without counter-holder
- Bar machining due to hollow spindle
- To be used horizontally or vertically
- Quick change through wedge clamping

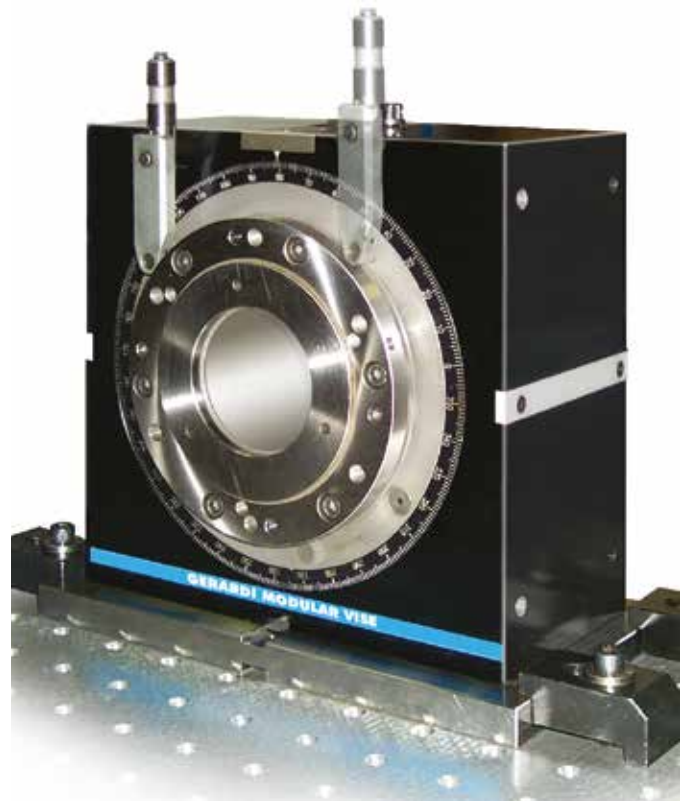

### DIVIGER 205

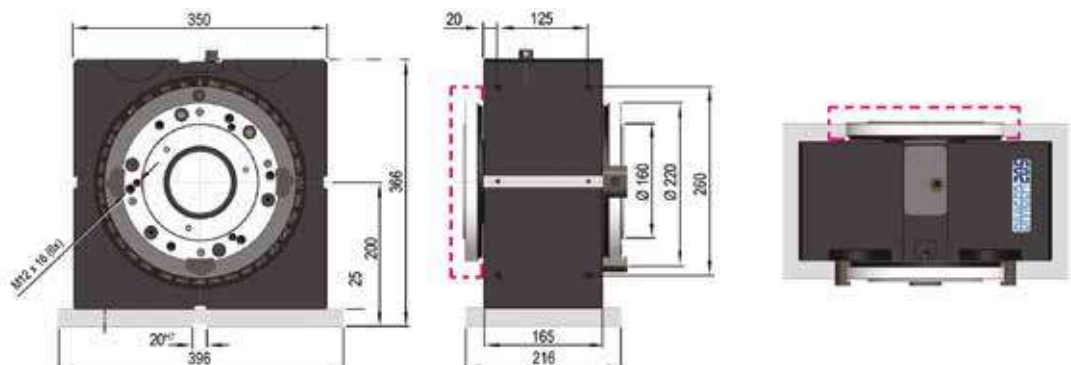

## Tipo (grandezza) morsa / Vise (type) size

 Divisore Gerardi **DIVIGER 205**  
 con cubo-morsa **FMS**  
 per serraggi singoli, doppi  
 o autocentranti

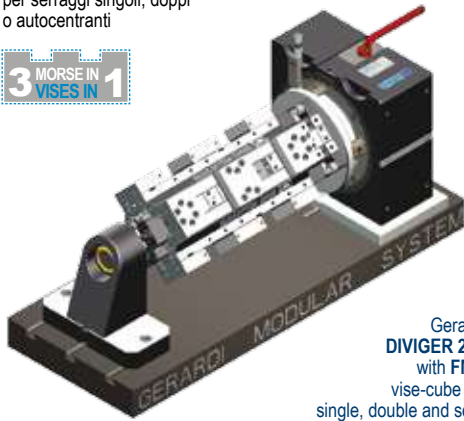
**3 MORSE IN 1**  
**VISES IN 1**

 Gerardi  
**DIVIGER 205**  
 with **FMS**  
 vise-cube for  
 single, double and self-  
 centering clamping

kN	1		2				3				
	25 kN		25 kN				30 kN				
D	200	300	300	400	500	600	400	500	600	700	800
G1	120		175				210				
W	74		94				124				
kg	30	45	53	70	88	106	90	112	135	157	180
Cod.	5.DI.V20500	5.DI.V20510	5.DI.V20520	5.DI.V20530	5.DI.V20540	5.DI.V20550	5.DI.V20560	5.DI.V20570	5.DI.V20580	5.DI.V20590	5.DI.V20511

**AMPLIA LE TUE APPLICAZIONI TRAMITE GLI ACCESSORI MODULARI ! - UPGRADE YOUR APPLICATIONS THROUGH MODULAR ACCESSORIES !**
**Art. 99A**

 Supporto  
 Support

Cod. 5.99.A2000

**Art. 99B**

 Perno di centraggio orizzontale  
 Horizontal centering pin

Cod. 5.99.B1000 5.99.B2000 5.99.B3000

**Art. 99H**

 Distanziale  
 Spacer



Cod. 5.99.H2000

**Art. 62**
**DIVIGER 205**

 Piastra di interfaccia DIVIGER 205 per FMS  
 DIVIGER 205 connecting plate for FMS

Cod. 5.62.804A05 5.62.804A06 5.62.804A07

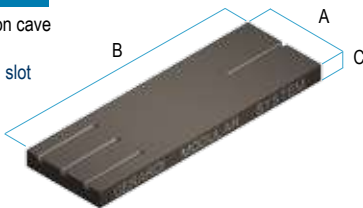
**Art. 99S**

 Piastra base con cave  
 Piani rettificati  
 Base plate with slot  
 Faces ground

Dimensioni B mm / Dimension B mm	A	C	Kg	Cod.	€
650	400	50	102	1.99.S065S	
950	400	50	149	1.99.S095S	
1250	400	50	195	1.99.S125S	

 Cave o fori calibrati su richiesta  
 Slot or calibrated holes on request

Disponibili quote "B" a step di 50mm - Available dimension "B" in steps of 50mm

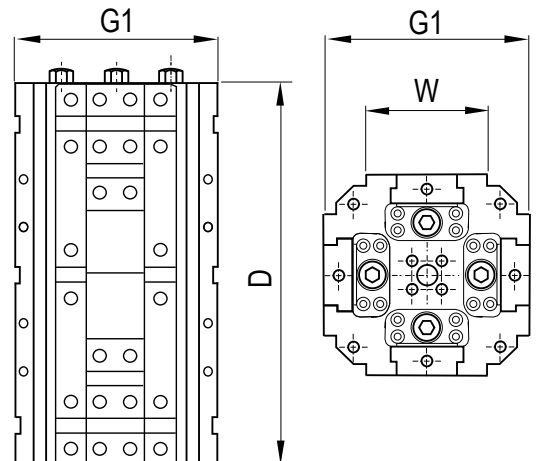
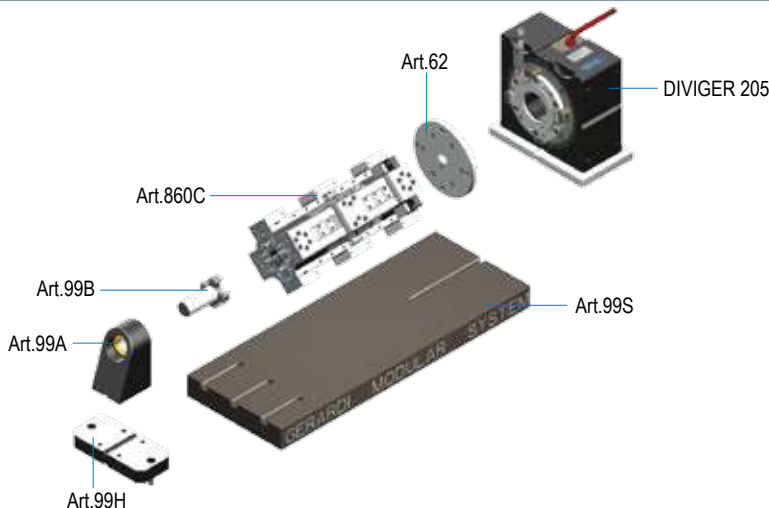



# DIAGRAMMI CON FORZE DI SERRAGGIO

## DIAGRAMS WITH CLAMPING FORCE

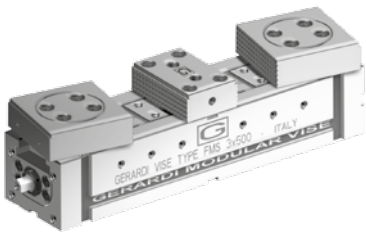

### SERRAGGIO MECCANICO CON CHIAVE DINAMOMETRICA

N.B. Alcuni fattori, come la lubrificazione, lo staffaggio, gli attriti ed altro, possono modificare i valori indicato fino al  $\pm 10\%$ . Per un corretto utilizzo non superare i valori indicati nel grafico

### MECHANICAL CLAMPING WITH TORQUE WRENCH

Some factor as lubrication, type of clamping on the machine table, frictions and more can modify above values within a  $\pm 10\%$  range. For optimum operation do not exceed chart values

## MORSE FMS TIPO 1

### FMS VISES TYPE 1

VITE: TPF 18 / 20 mm PASSO: 2 mm  
 SCREW: TPF 18 / 20 mm PITCH: 2 mm

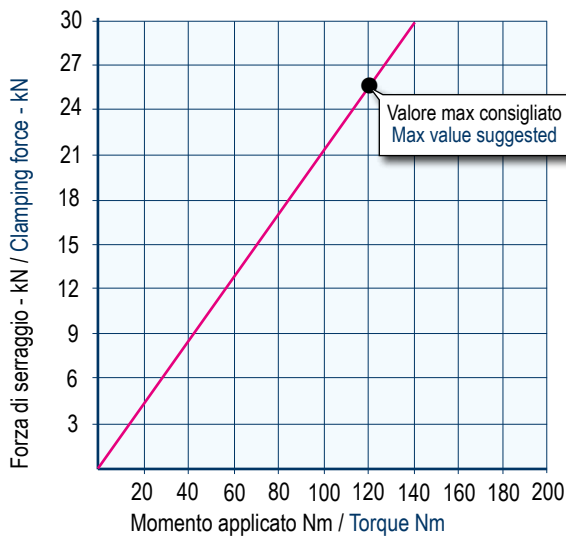

## MORSE FMS TIPO 2

### FMS VISES TYPE 2

VITE: TPF 18 / 24 mm PASSO: 2 mm  
 SCREW: TPF 18 / 24 mm PITCH: 2 mm

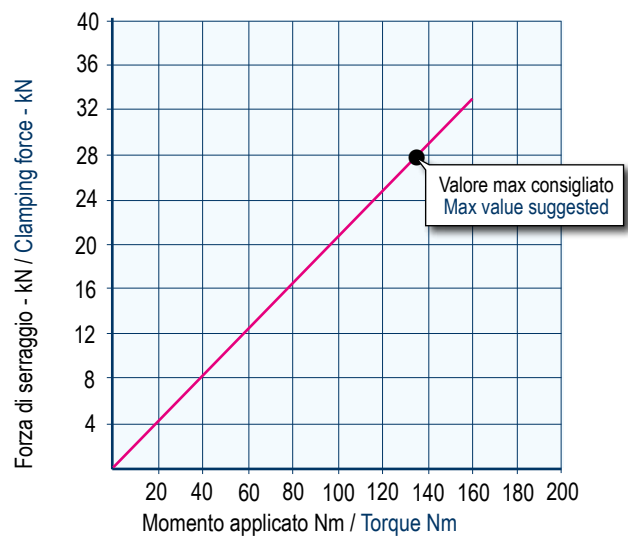

## MORSE FMS TIPO 3-4

### FMS VISES TYPE 3-4

VITE: TPF 24 / 30 mm PASSO: 2 mm  
 SCREW: TPF 24 / 30 mm PITCH: 2 mm

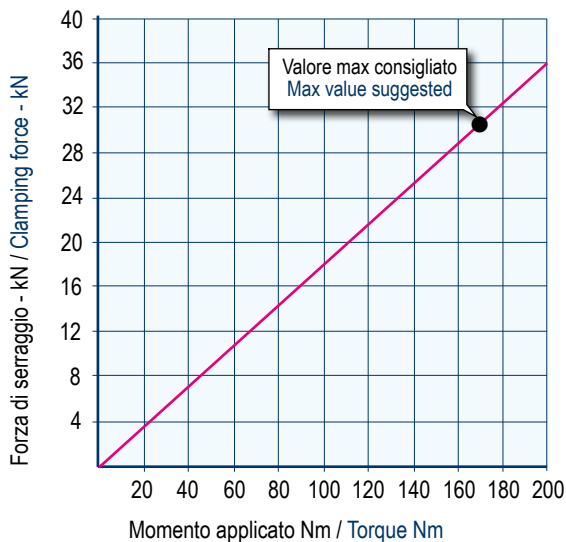

## MORSE FMS TIPO 5-6

### FMS VISES TYPE 5-6

VITE: TPF 30 / 36 mm PASSO: 3 mm  
 SCREW: TPF 30 / 36 mm PITCH: 3 mm

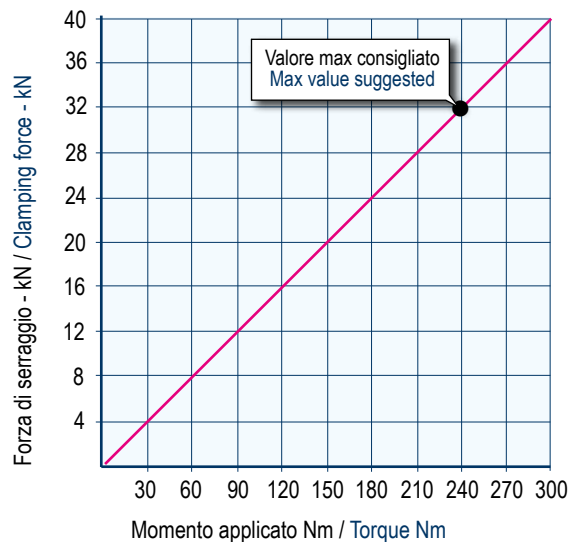



# DIAGRAMMI CON FORZE DI SERRAGGIO

# DIAGRAMS WITH CLAMPING FORCE

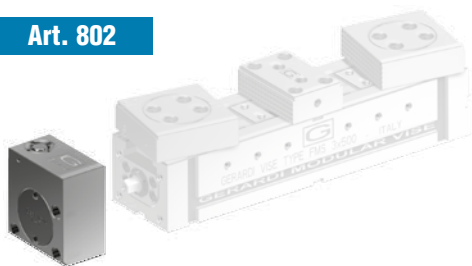
**Art. 802**

## SERRAGGIO MECCANICO CON MOLTIPLICATORE DI POTENZA Art.802

N.B. Alcuni fattori, come la lubrificazione, lo staffaggio, gli attriti ed altro, possono modificare i valori indicati fino al  $\pm 10\%$ .  
 Per un corretto utilizzo non superare i valori indicati nel grafico

## MECHANICAL CLAMPING WITH PRESSURE MULTIPLIER Art.802

Some factor as lubrication, type of clamping on the machine table, frictions and more can modify above values within a  $\pm 10\%$  range. For optimum operation do not exceed chart values

### MORSE FMS TIPO 1

### FMS VISES TYPE 1

VITE: TPF 18 / 20 mm PASSO: 2 mm  
 SCREW: TPF 18 / 20 mm PITCH: 2 mm  
 Moltiplicatore di potenza: Art. 802  
 Pressure multiplier: Art. 802  
 Rapporto di trasmissione: 1/9 / Gear ratio: 1/9

Type 1	
Cod.	5.80.21000
€	<b>862</b>

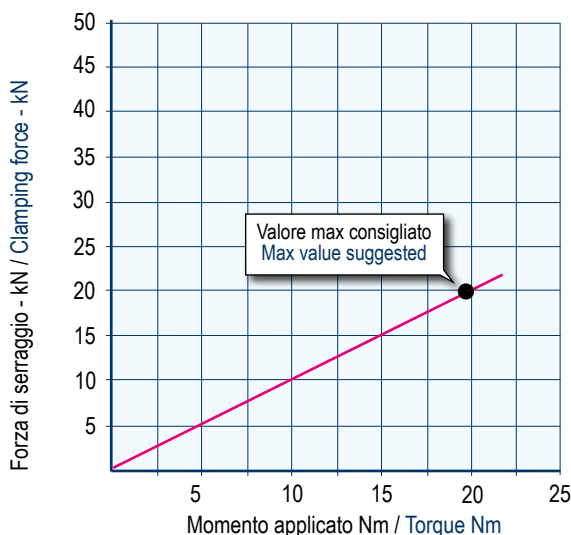

### MORSE FMS TIPO 2

### FMS VISES TYPE 2

VITE: TPF 18 / 24 mm PASSO: 2 mm  
 SCREW: TPF 18 / 24 mm PITCH: 2 mm  
 Moltiplicatore di potenza: Art. 802  
 Pressure multiplier: Art. 802  
 Rapporto di trasmissione: 1/7 / Gear ratio: 1/7

Type 2	
Cod.	5.80.22000
€	<b>862</b>

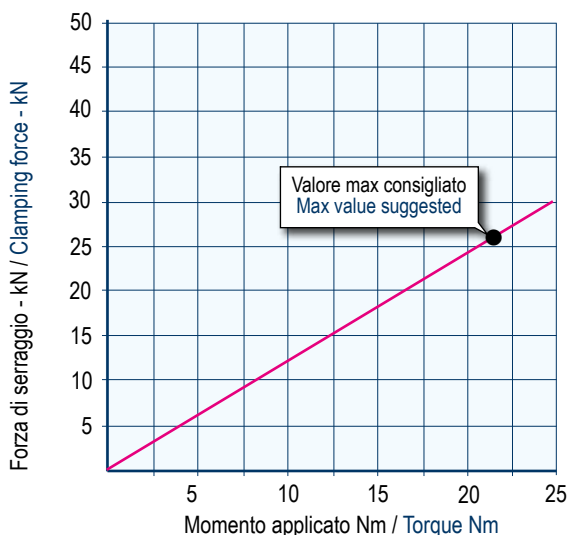

### MORSE FMS TIPO 3-4

### FMS VISES TYPE 3-4

VITE: TPF 24 / 30 mm PASSO: 2 mm  
 SCREW: TPF 24 / 30 mm PITCH: 2 mm  
 Moltiplicatore di potenza: Art. 802  
 Pressure multiplier: Art. 802  
 Rapporto di trasmissione: 1/7 / Gear ratio: 1/7

Type 3	
Cod.	5.80.23000
€	<b>907</b>
Type 4	
Cod.	5.80.24000
€	<b>1.114</b>

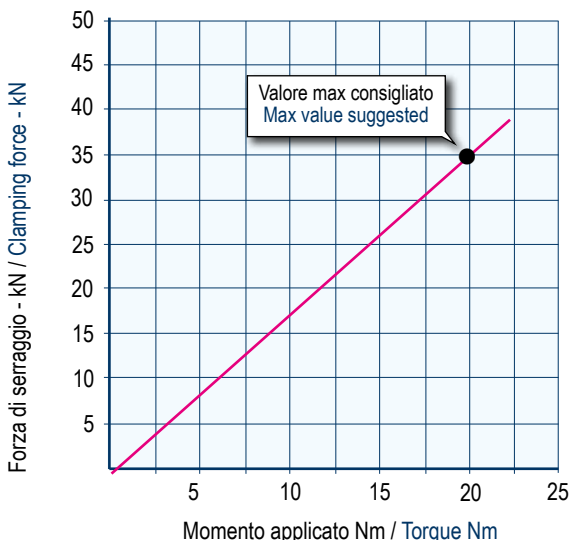

### MORSE FMS TIPO 5-6

### FMS VISES TYPE 5-6

VITE: TPF 30 / 36 mm PASSO: 3 mm  
 SCREW: TPF 30 / 36 mm PITCH: 3 mm  
 Moltiplicatore di potenza: Art. 802  
 Pressure multiplier: Art. 802  
 Rapporto di trasmissione: 1/7 / Gear ratio: 1/7

Type 5	
Cod.	5.80.25000
€	<b>1.215</b>
Type 6	
Cod.	5.80.26000
€	<b>1.209</b>

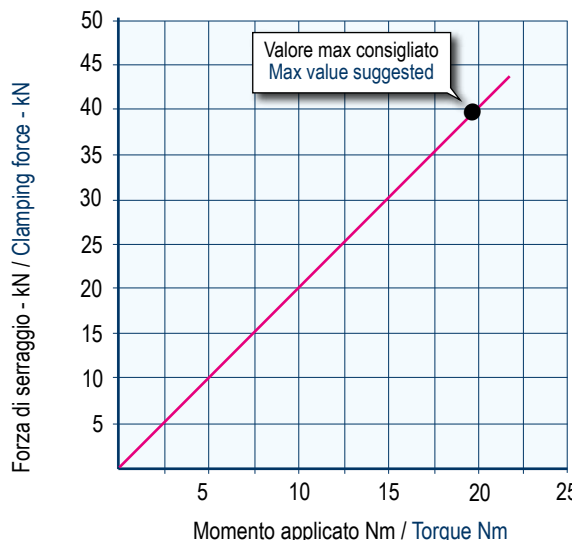

# DIAGRAMMI CON FORZE DI SERRAGGIO DIAGRAMS WITH CLAMPING FORCE

Art. 890

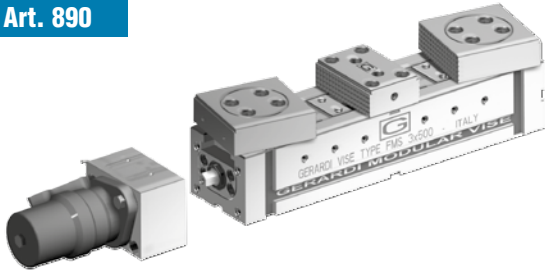

## MORSE FMS TIPO 1 FMS VISES TYPE 1

VITE: TPF 18 / 20 mm PASSO: 2 mm  
SCREW: TPF 18 / 20 mm PITCH: 2 mm  
Motore idraulico tipo **OMM 32**  
Hydraulic motor type **OMM 32**

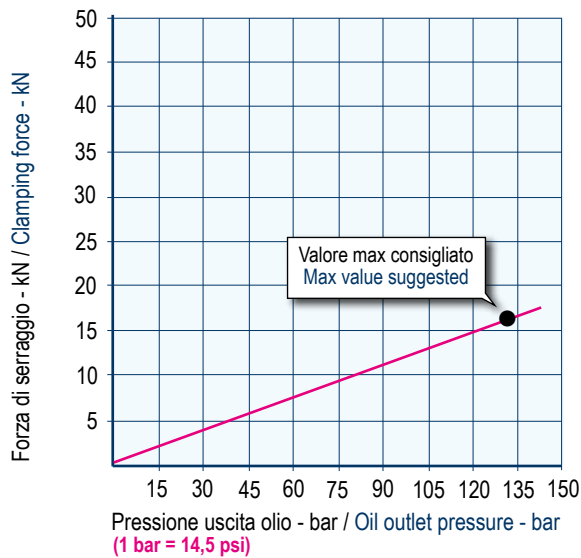

## MORSE FMS TIPO 3-4 FMS VISES TYPE 3-4

VITE: TPF 24 / 30 mm PASSO: 2 mm  
SCREW: TPF 24 / 30 mm PITCH: 2 mm  
Motore idraulico tipo **OMR 200**  
Hydraulic motor type **OMR 200**

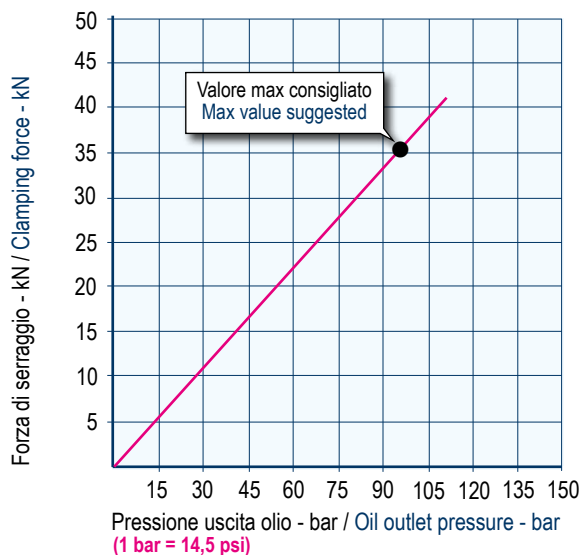

## SERRAGGIO MECCANICO TRAMITE MOTORE IDRAULICO Art.890

N.B. Alcuni fattori, come la lubrificazione, lo staffaggio, gli attriti ed altro, possono modificare i valori indicati fino al  $\pm 10\%$ .  
Per un corretto utilizzo non superare i valori indicati nel grafico

**ATTENZIONE! Azionamento idraulico ma serraggio meccanico (PIU' SICURO)**

## MECHANICAL CLAMPING THROUGH HYDRAULIC MOTOR Art.890

Some factor as lubrication, type of clamping on the machine table, frictions and more can modify above values within a  $\pm 10\%$  range. For optimum operation do not exceed chart values

**IMPORTANT! Hydraulic control, but mechanical clamping (SAFER)**

## MORSE FMS TIPO 2 FMS VISES TYPE 2

VITE: TPF 18 / 24 mm PASSO: 2 mm  
SCREW: TPF 18 / 24 mm PITCH: 2 mm  
Motore idraulico tipo **OMP 80**  
Hydraulic motor type **OMP 80**

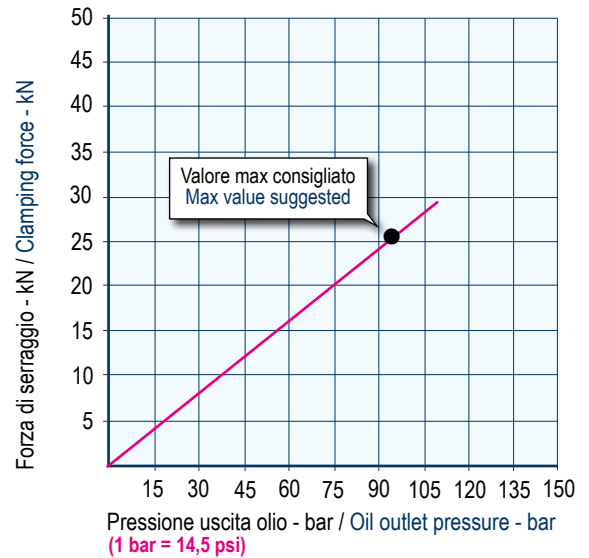

## MORSE FMS TIPO 5-6 FMS VISES TYPE 5-6

VITE: TPF 30 / 36 mm PASSO: 3 mm  
SCREW: TPF 30 / 36 mm PITCH: 3 mm  
Motore idraulico tipo **OMR 200**  
Hydraulic motor type **OMR 200**

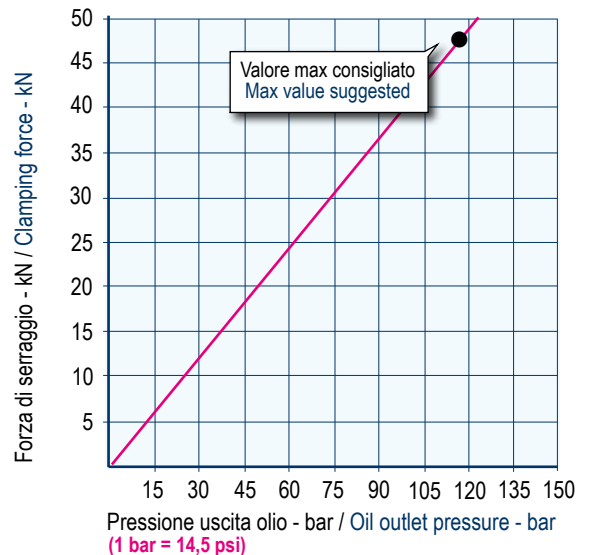

# CONSIGLI PER L'UTILIZZO E LA MANUTENZIONE DELLE MORSE FMS INSTRUCTIONS FOR THE USE AND MAINTENANCE OF FMS VISES

**3** MORSE IN  
**VICES** IN **1**



5



**SERRAGGI SINGOLI**  
**SINGLE CLAMPING**

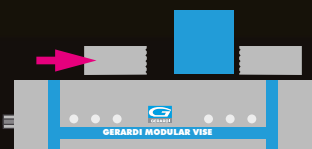

**SERRAGGI DOPPI**  
**DOUBLE CLAMPING**

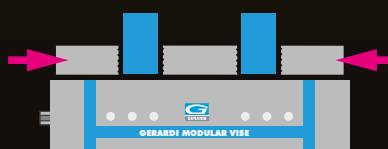

**AUTOCENTRANTE**  
**SELF-CENTERING**

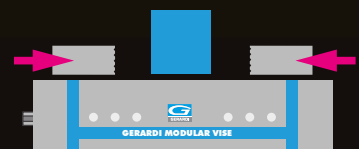

# UTILIZZO E MANUTENZIONE DELLE MORSE FMS USE AND MAINTENANCE OF FMS VISES



Morse Singole, doppie, autocentranti - Single, double, self-centering Vises

## 1

Fare riferimento al disegno esploso, che accompagna tutte le morse e che riporta tutti i particolari costituenti la morsa FMS, denominati con numero di articolo, e riferiti sempre al tipo di morsa all'atto dell'acquisto.

Refer to your explosion view drawing accompanying all our vises and which identifies each part with its own article number. When requesting service or spare parts always refer to the vise type number.

## 2

La morsa può essere smontata seguendo attentamente tutte le istruzioni ed operazioni qui sotto descritte. Si consiglia vivamente di marcare pezzi e posizioni di tutti i particolari e rimontarli esattamente nella medesima posizione in cui sono stati smontati.

By the carefully following procedure and instructions the vise can be dismantled. We suggest all parts and their positions be marked so they can readily be reassembled to their original state.

### OPERAZIONE 1

Togliere tutte le ganasce dal modulo base Art.855

### OPERATION 1

Remove all the jaws from the vise module Art.855

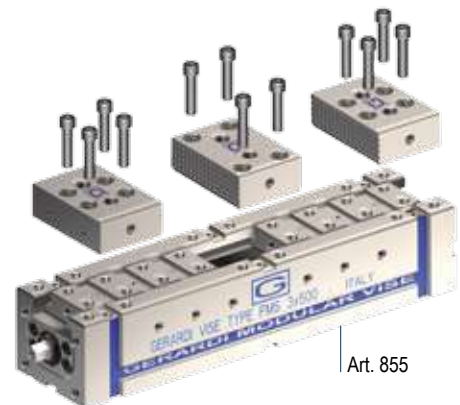

### OPERAZIONE 2

Adesso il modulo base è completamente libero da ogni impedimento. Pulire attentamente il modulo base con un diluente appropriato. (Gasolio ecc).

### OPERATION 2

Now the vise body module is completely free. Clean thoroughly with detergent oil or grease remover.

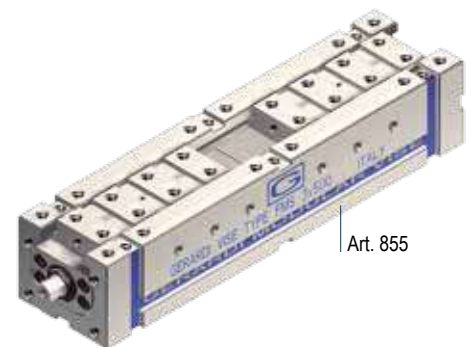

### OPERAZIONE 3

Togliere le 4 viti di testa Art. 801I dalla piastra di contenimento Art.825

### OPERATION 3

Unscrew and remove the 4 screws Art. 801I from the main screw holding plate Art.825

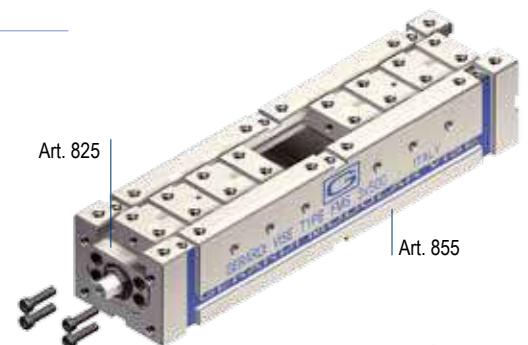

### OPERAZIONE 4

Togliere la piastra di contenimento Art.825

### OPERATION 4

Remove the main screw holding plate Art.825

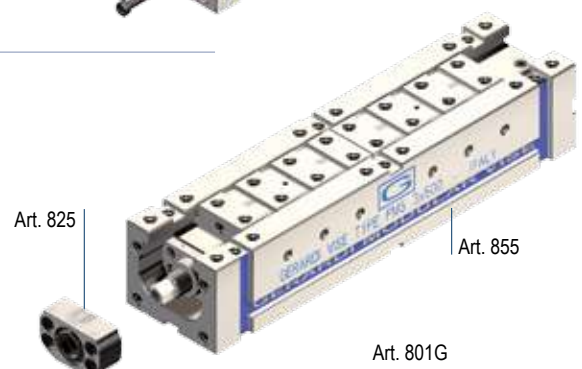



## UTILIZZO E MANUTENZIONE DELLE MORSE FMS USE AND MAINTENANCE OF FMS VISES

Morse Singole, doppie, autocentranti - Single, double, self-centering Vises

### OPERAZIONE 5

Girare la vite **Art. 822** in senso orario, affinché si possa togliere la vite **Art. 810G** dai ripari.

### OPERATION 5

Turn the main screw **Art. 822** clockwise in order to remove the screw **Art. 810G** from cover.

### OPERAZIONE 6

Collegare le due slitte **Art. 829A - Art. 830**, utilizzando la piastrina di collegamento in dotazione **Art. 801S**, per non perdere la fase di posizionamento slitte.

### OPERATION 6

Connect the 2 slides **Art. 829A - Art. 830**, using the connecting plate in the STD equipment **Art. 801S**, in order not to lose the slides reference on the main screw and also for safety reasons.

### OPERAZIONE 7

Sfilare la vite **Art. 822** assieme con le due slitte e la piastra intermedia **Art. 823**

### OPERATION 7

Remove the main screw **Art. 822** together with the 2 slides and the intermediaire plate **Art. 823**

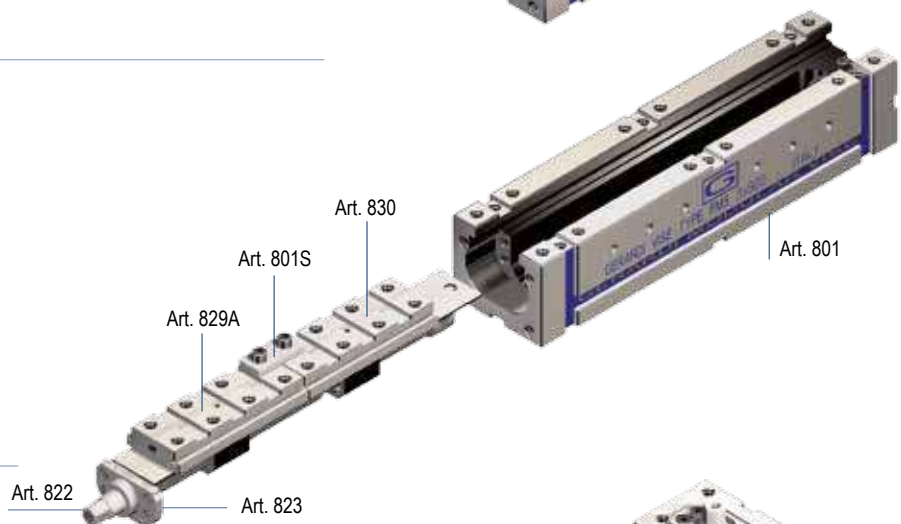

### OPERAZIONE 8

Per rimontare la morsa, eseguire tutte le 8 operazioni in senso inverso senza forzare nel rimontaggio nessun particolare. L'unica manutenzione richiesta (a parte la periodica pulizia interna ed esterna della morsa) è la lubrificazione settimanale con olio molto fluido negli appositi fori situati nelle slitte. Il foro da scegliere per la lubrificazione dipende dalla posizione della morsa.

### OPERATION 8

To reassemble the vise perform the 8 previous operations reverse order without forcing any stage or part. The only maintenance required (apart from periodic Internal and external vise cleaning) is weekly lubrication with low viscosity oil in the proper holes in the slides. Which lubrication hole is chosen depends on the vise position.

La morsa sopra descritta è completamente a chiusura MECCANICA MANUALE. I vari dispositivi, ossia i moltiplicatori di forza MANUALI, OLEODINAMICI, ELETTRICI ed OLEOPNEUMATICI, sono completamente autonomi e possono essere applicati o tolti dalle morse FMS senza modifica alcuna. La chiusura della morsa è sempre e comunque meccanica. (Vite/chiocciola)

This vise described above is for fully manual MECHANICAL CLAMPING. The various accessories we offer, MECHANICAL, HYDRAULIC, ELECTRIC or IDROPNEUMATIC torque multipliers are independent units that can be added or removed without affecting the basic vise. Vise clamping is always mechanical through nut and screw.

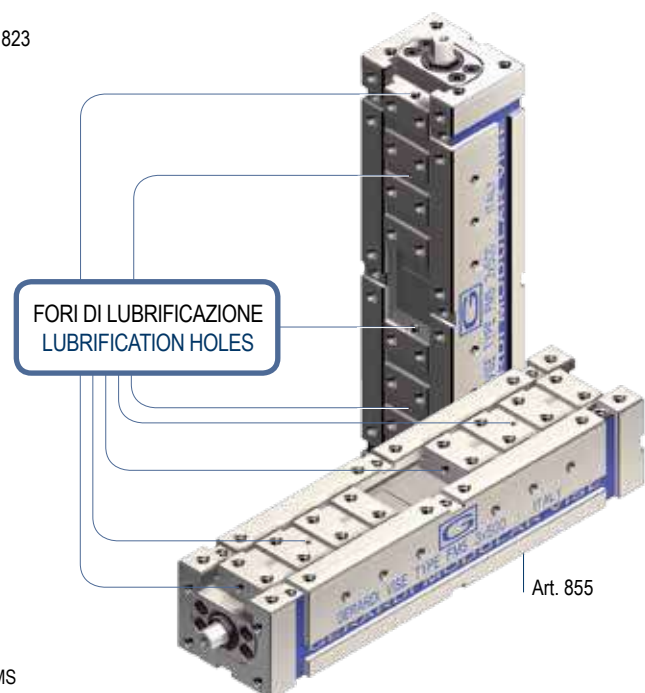

## FUNZIONAMENTO DELLA MORSA FMS FMS VISE OPERATION

### MORSA DOPPIA

Con la ghiera **Art.825A** aperta, allineata alla piastra di contenimento **Art.825 - Fig.1**, la morsa e' predisposta per un doppio serraggio con uno scarto dimensionale massimo fra i due pezzi da bloccare di 8mm.

### DOUBLE STATION VISE

With the locking **Art.825A** open, aligned to the main screw holding plate **Art.825 - Pic.1** the vise configuration is for a double clamping with a max difference between workpieces of 8mm.

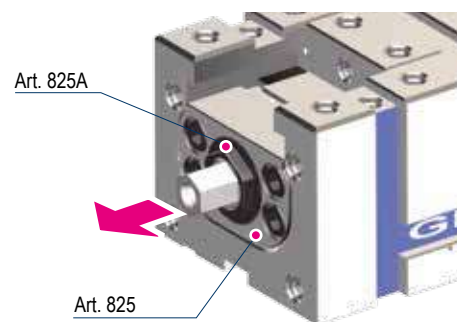

Fig. 1

### MORSA AUTOCENTRANTE

Con la ghiera **Art.825A** chiusa, all'interno della piastra di contenimento **Art. 825 - Fig.2**, la morsa è predisposta per il bloccaggio autocentrante di un solo pezzo (sono possibili sia bloccaggi esterno-interno che interno-esterno)

**ATTENZIONE:** In questa situazione il centro pezzo rispetto al centro cava è disassato di 2 mm verso la chiave di serraggio.

### SELF CENTERING VISE

With the locking **Art.825A** closed, inside the main screw holding plate **Art.825 - Pic.2**, the vise configuration is for a self-centering clamping of one single piece (external to internal and internal o external clampings are possible)

**ATTENTION:** With this configuration the work-piece center with respect to the center slot is disaligned of 2 mm toward the clamping wrench

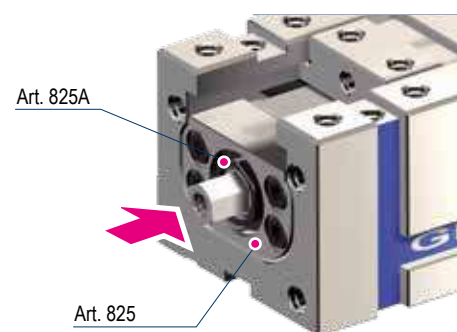

Fig. 2

### MORSE SINGOLA

Sia con la ghiera **Art.825A** aperta che chiusa (punti 1 e 2) è possibile il serraggio di un unico pezzo con riferimento fisso.

### SINGLE STATION VISE

With open and closed locking **Art.825A** it is possible to clamp a single piece with a fixed reference point

## COME TRASFORMARE LA MORSA FMS AUTOCENTRANTE IN UNA A BLOCCAGGIO SINGOLO o DOPPIO

## RESETTING OPERATIONS TO TRANSFORM SELF-CENTERING FMS VISE TO DOUBLE or SINGLE CLAMPING

### OPERAZIONE 1

Inserire la bussola esagonale **Art.850H** nella sede della ghiera di riferimento **Art.825A**

### OPERATION 1

Insert the hexagonal bushing **Art.850H** in the locking **Art.825A**

### OPERAZIONE 2

Inserire la chiave a pipa **Art.375** nella bussola esagonale **Art.850H**

### OPERATION 2

Put the box wrench **Art.375** inside the hexagonal bushing **Art.850H**

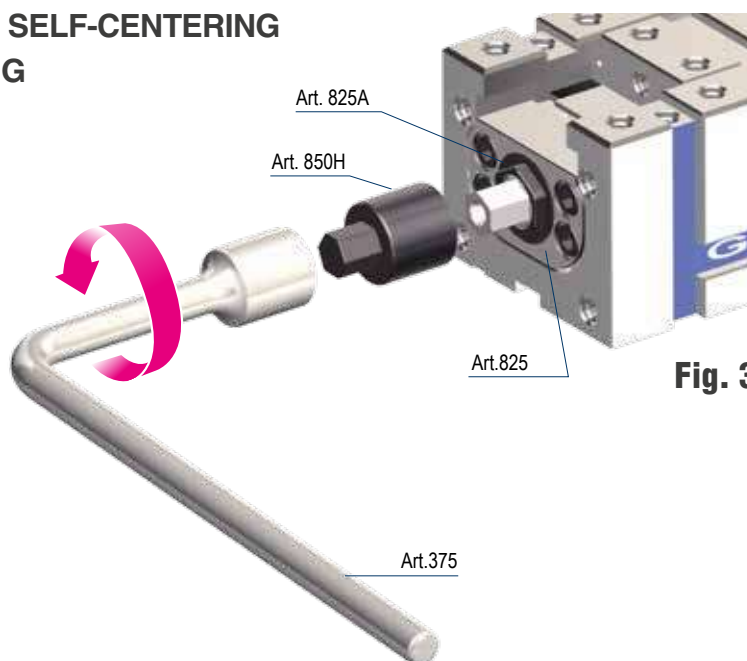

Fig. 3



### OPERAZIONE 3

Girare la chiave a pipa in senso **antiorario** fino a portare la ghiera **Art.825A - Fig 3** a sporgere dalla piastra di contenimento **Art.825**

### OPERATION 3

Turn the box wrench **anticlockwise** to bring the locking **Art.825A - Pic.3** open in line with main screw holding plate **Art.825**

A questo punto la morsa FMS puo' serrare 2 pezzi contemporaneamente anche se le dimensioni tra loro sono diverse, con un margine di 8mm circa.

Può anche essere utilizzata per serraggi singoli, per il serraggio di un unico pezzo, spostando la ganasca fissa centrale (**Fig.4**) in una delle 2 cave laterali e naturalmente, rimuovendo una delle 2 ganasce mobili.

Per ottenere tutte le aperture possibili (data la lunghezza della base) può, in certe posizioni essere necessario l'utilizzo di ganasce speciali o spessori.

Now the FMS vise can clamp 2 work-pieces different dimensions (max difference 8mm). At the same time the vise can also be used as single station clamping by moving the central fix jaw (**Pic. 4**) in one of the 2 lateral positioning slots and of course by removing one movable jaw.

In order to reach all the possible openings (given the base length) it could be necessary, in some positions, the use of specials jaws or spacers.



Fig. 4



## COME TRASFORMARE LA MORSA FMS DA BLOCCAGGIO DOPPIO AD AUTOCENTRANTE RESETTING OPERATIONS TO TRANSFORM DOUBLE CLAMPING VISE TO SELF-CENTERING

### OPERAZIONE 1

Inserire la bussola esagonale **Art.850H** nella sede della ghiera di riferimento **Art.825A**

### OPERATION 1

Insert the hexagonal bushing **Art.850H** in the locking **Art.825A**

### OPERAZIONE 2

Inserire la chiave a pipa **Art.375** nella bussola esagonale **Art.850H**

### OPERATION 2

Put the box wrench **Art.375** inside the hexagonal bushing **Art.850H**

### OPERAZIONE 3

Girare la chiave a pipa **Art.375** in senso **orario** fino a portare la ghiera in battuta, ossia all'interno della piastra di contenimento (non forzare il serraggio). **Fig. 5**

### OPERATION 3

Turn the hexagonal wrench **Art.375 clockwise** to reach with the locking the bottom position, that inside the main screw holding plate (do not force the clamping). **Pic.5**

### OPERAZIONE 4

A questo punto la morsa FMS è autocentrante, può quindi serrare 1 pezzo garantendo il riferimento centrale dello stesso.

### OPERATION 4

Now the FMS vise is self-centering, so it can clamp 1 work-piece and guarantee its central reference point.

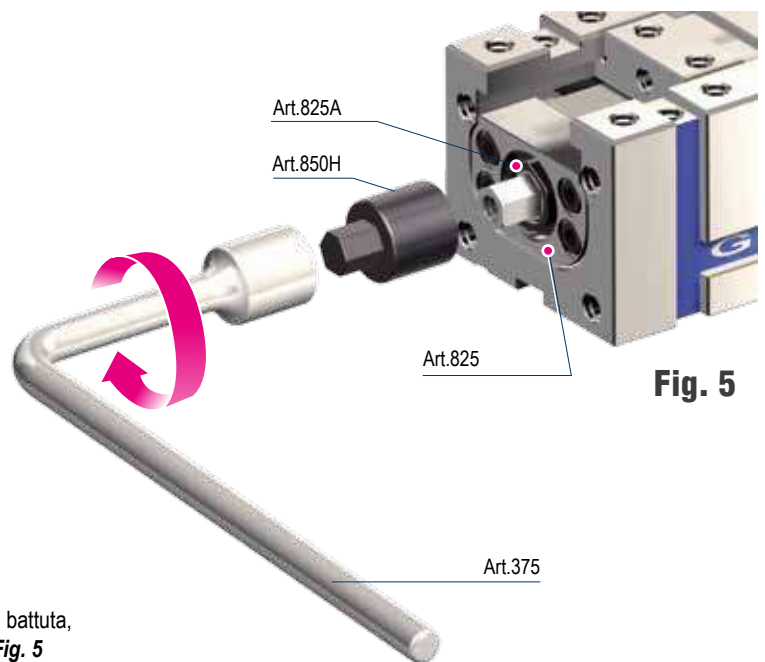
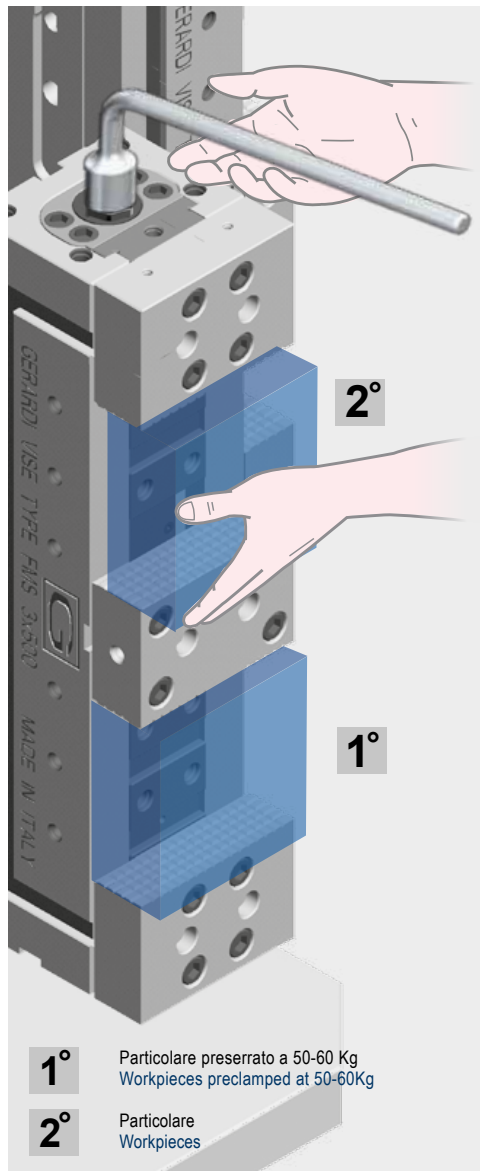

Fig. 5

## DISPOSITIVO TERZA MANO per morse FMS doppie THIRD HAND ACCESSORY for double FMS vises



### DISPOSITIVO TERZA MANO PER MORSE FMS DOPPIE

Il meccanismo "Terza mano" nella morsa in versione a doppia stazione, consente il carico e serraggio lieve del primo pezzo (dalla parte opposta alla chiave nella stazione inferiore della morsa), mentre nel frattempo viene caricato il secondo pezzo (da cui la denominazione "Terza mano"). Tale dispositivo risulta particolarmente utile quando la morsa viene usata in posizione verticale. Con il dispositivo "Terza mano", i due particolari da lavorare possono essere di dimensioni diverse con uno scarto massimo fra loro di 2 mm.

Il meccanismo "Terza mano" standard ha una spinta di max 50 Kg. Volendo ottenere una spinta maggiore, basta sostituire le molle in dotazione con altre di maggior potenza (attenzione però a mantenere la stessa quota di altezza del pacchetto molle) oppure aggiungendo un altro distanziale di max. 3mm

**N.B: sostituendo le molle o aggiungendo un distanziale extra bisogna tener presente che il maggior precarico comporterà lo stesso carico di spinta anche girando la vite Art.822 a vuoto.**

Non volendo il meccanismo "Terza Mano", il tutto può essere semplicemente rimosso togliendo le molle con i relativi distanziali dalla loro sede naturale.

**Attenzione!! Assicurarsi che Art.850N rimanga fissato nella morsa per proteggere l'eventuale entrata di trucioli.**

### THIRD HAND DEVICE FOR DOUBLE STATION FMS VISES

The "Third Hand" device in the double station vise configuration, allows the first workpiece loaded to be gripped/clamped lightly with a little pressure (on the opposite side of the wrench and then in the lower vise station), while the second workpiece is being loaded (from here the "third Hand" denomination). Such device is useful especially with the vise vertically positioned.

With the "Third Hand" device the two workpiece can be up to 2 mm different in gripping width.

The standard "Third Hand" device has a max pressure of 50 Kg.

In order to reach a higher clamping power it is enough to preload by changing the standard springs with more powerful ones or by adding a spacer (max 3 mm). Be careful that remains the same spring and spacer packing height dimensions.

**P.S: By changing springs or adding extra spacer remember that the higher preload will give the same resistance (given by the more powerful preload) even just turning the main screw Art.822 freely.**

If the "Third Hand" device is not required, it could be simply removed by taking away the springs and their spacers from their standard position.

**Attention!! Make sure that the Art.850N remains fixed in the vise to provide protection from dirt getting inside the vise.**

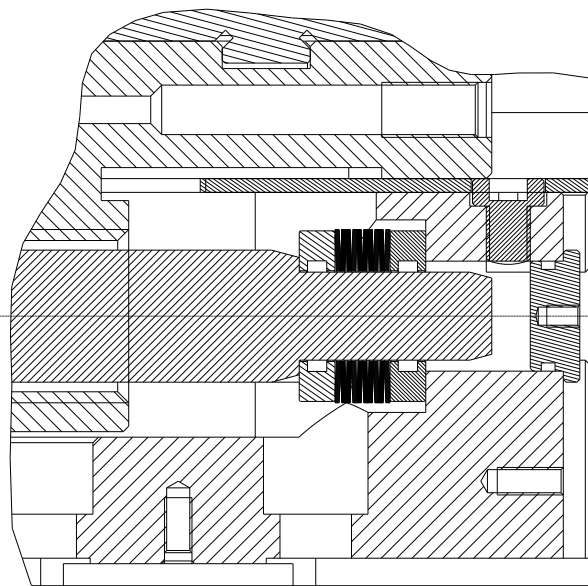

### Art.850P



## FUNZIONAMENTO COMANDO CENTRALINE ELETTROIDRAULICHE ELECTRO-HYDRAULIC POWER PACK UNIT INSTRUCTIONS

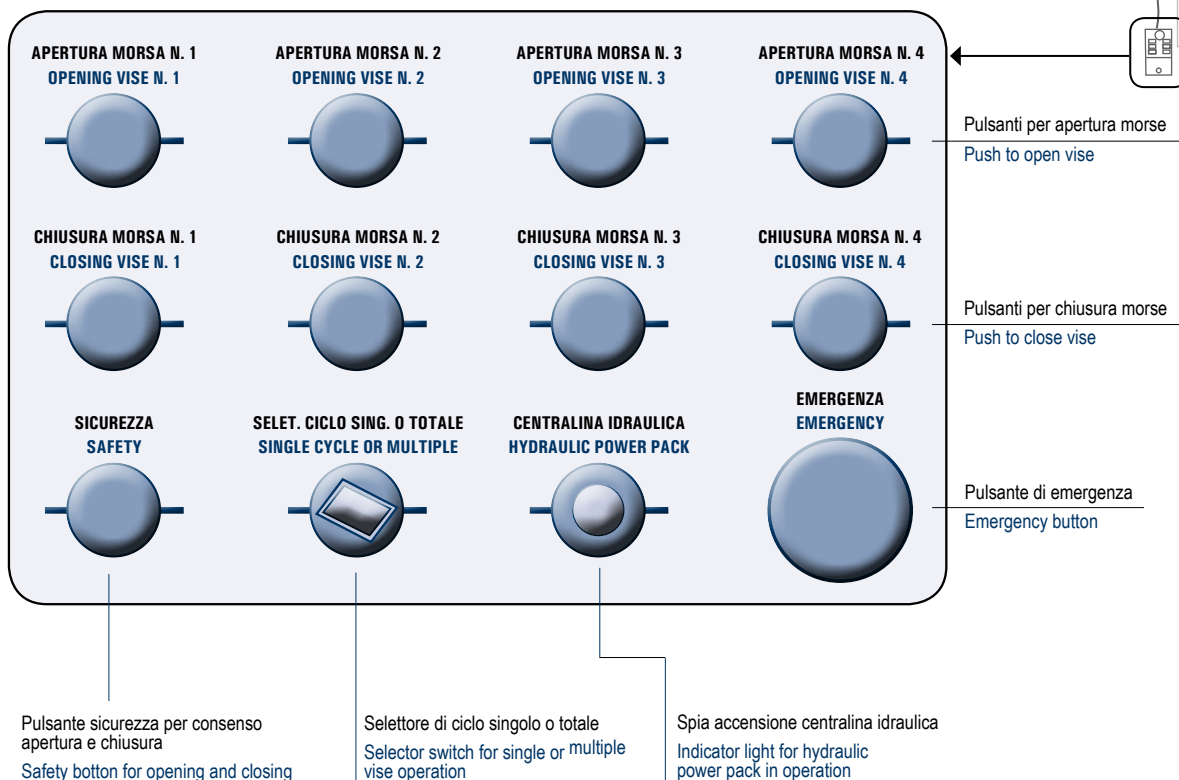
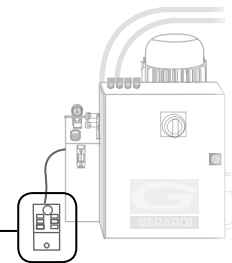

### FUNZIONAMENTO

Per comandare l'apertura o la chiusura delle morse, e' necessario, dopo avere acceso la centralina olio, premere un pulsante per il movimento contemporaneamente al pulsante di "sicurezza".  
Per la chiusura occorre tenere premuti i pulsanti fino a pezzo bloccato.  
Dopodiché entra in funzione il dispositivo di finecorsa automatico che sblocca l'elettrovalvola. per l'apertura tenere premuto fino al finecorsa elettromeccanico.  
Per comandare il movimento di ogni morsa singolarmente, girare il selettore (sing.-totale) sulla posizione "o" (singolo).  
Per ottenere il movimento contemporaneo di tutte le morse, girare il selettore sulla posizione "i" (totale).

### ATTENZIONE !

Accertarsi prima di comandare i movimenti, che la spia "centralina idraulica" sia accesa, e che nessuna persona sia in prossimita' delle morse, per evitare infortuni.

### OPERATION - INSTRUCTION

To regulate the opening and closing of the vises it is necessary leaving turned on the main switch of the hydraulic power pack, to push the safety switch (button) at the same time as the open (or close) vise switch.

At the maximum opening of the vise the jaw movement limiting micro-switch will switch off jaw traverse.

To open or close the vises all together repeat the operation with the selector switch set to "multiple".

### ATTENTION !

Before operating vises always make sure there are no person in the immediate vicinity.

Tipo di olio raccomandato: **MOBIL VACUOLINE OIL 1405**  
Cambiare filtro ogni **400** ore lavorative  
Cambiare olio ogni **2000** ore lavorative  
Lubrificazione vite e slitte morsa: **OLIO FLUIDO A BASSA VISCOSITA'**

Type of oil recommended: **MOBIL VACUOLINE OIL 1405**  
Change filter every **400** operating hours  
Change oil every **2000** operating hours  
Lubrification of vise screw & slides: **WITH LOW VISCOSITY OIL**

# ISTRUZIONI PER UN CORRETTO UTILIZZO INSTRUCTIONS FOR A PROPER USE

## TOLLERANZE GEOMETRICHE

## GEOMETRIC ACCURACIES

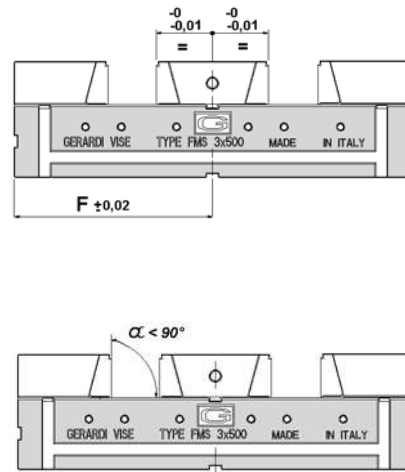
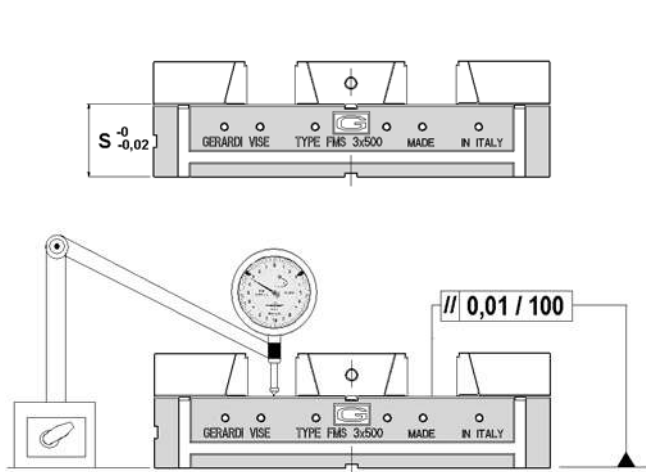

## TOLLERANZE DINAMICHE

## DINAMIC ACCURACIES

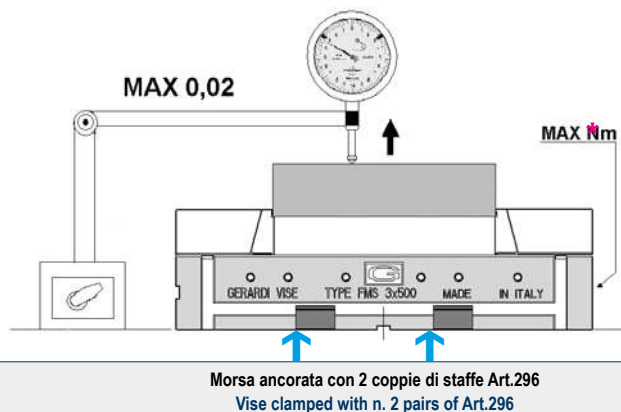
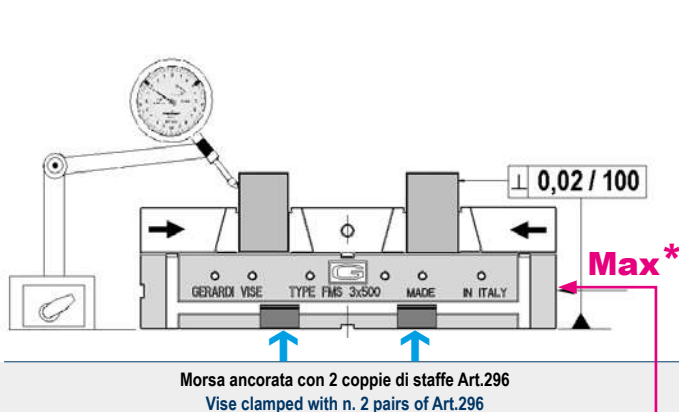

Art 865		* Coppia applicata - Torque Nm	Forza di serraggio - Clamping power
Morsa tipo 1	Vise type 1	120	2500 Kgf
Morsa tipo 2	Vise type 2	140	2500 Kgf
Morsa tipo 3	Vise type 3	180	3000 Kgf
Morsa tipo 4	Vise type 4	180	3000 Kgf
Morsa tipo 5	Vise type 5	240	3200 Kgf
Morsa tipo 6	Vise type 6	240	3200 Kgf

\* Max coppia applicabile per non superare i valori consigliati

1 kgf . m = 9.806